

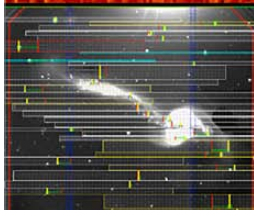

Gemini **FOCUS** Publication of the Gemini Observatory
July 2015

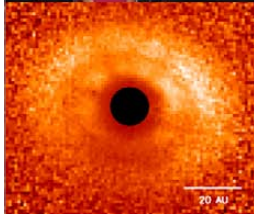
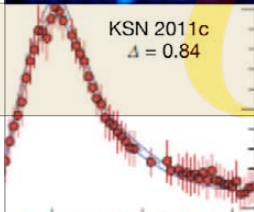

GeminiFocus

1 Director's Message

Markus Kissler-Patig

4 First Likely Planets in a Nearby Circumbinary Disk

Valerie Rapson

8 Science Highlights

Nancy A. Levenson

11 News for Users

Gemini staff contributions

16 On the Horizon

Gemini staff contributions

21 Seeing Where Stars Collide

Gemini Public Image Release

ON THE COVER:

Gemini Observatory near-infrared image of the globular cluster Liller 1 obtained with the GeMS adaptive optics system on the Gemini South telescope in Chile.



GeminiFocus July 2015

GeminiFocus is a quarterly publication of the Gemini Observatory

670 N. A'ohoku Place, Hilo, Hawai'i 96720, USA
Phone: (808) 974-2500 Fax: (808) 974-2589

Online viewing address:

www.gemini.edu/geminifocus

Managing Editor: Peter Michaud

Science Editor: Nancy A. Levenson

Associate Editor: Stephen James O'Meara

Designer: Eve Furchgott/[Blue Heron Multimedia](#)

Any opinions, findings, and conclusions or recommendations expressed in this material are those of the author(s) and do not necessarily reflect the views of the National Science Foundation or the Gemini partnership.



Markus Kissler-Patig

Director's Message

Gemini in 2015: An Eye to the Future

Gemini is on a strong, focused path that will strengthen our current instrument capabilities, broaden our user possibilities, and solidify international partnership agreements well into the future.

As I write these words, members of the Gemini community are gathering in Toronto, Canada, for the triennial Future and Science of Gemini Observatory users' meeting. Input from this meeting will help shape Gemini's future beyond the changes we've already made in operations over the last three years. These changes in operations, as well as the now available full four-instrument (plus adaptive optics) complement at each telescope, have set us on a strong, user-focused path for the next few years. Now priorities for the 2020's are being discussed amongst all of our stakeholders in Toronto.

Looking Ahead

The 2016-2021 International Gemini Agreement provides the terms under which the Partnership currently operates. With the decade beginning in 2020 appearing on the horizon, the next Agreement is slated for preparation in 2018. This process began at the Gemini Board meeting in Hilo last May (see Board recommendations [here](#)), and continued in Toronto in June.

Gemini's long-range planning is happening in concert with other exciting developments in telescope facilities in both hemispheres, as well as in space: In the south, the Atacama Large Millimeter/submillimeter Array (ALMA) will be operating routinely; the Large Synoptic Survey Telescope (LSST) plans to begin its 10-year deep survey of the entire visible sky in 2021; and the Giant Magellan Telescope (GMT), as well as the European Extremely Large Telescope (E-ELT) are expected to see first light in 2021 and 2024, respectively.

Figure 1.

Representatives of the Gemini community assembled at the triennial Future and Science of Gemini Observatory users' meeting in Toronto, Canada. Over 130 participants attended the meeting.



Meanwhile, in the north, the Thirty Meter Telescope (TMT) will begin leading astronomical research on Maunakea with operations expected to start in the early 2020s (see comments below). Finally, the James Webb Space Telescope (JWST) will be operating for a large fraction of the decade once it is launched in 2018. All this represents an exciting landscape and opportunity for Gemini to further unfold our two major strengths: flexibility and complementarity.

Here and Now

Gemini continues to broaden the possibilities for our users when applying for observing time. For instance, we just concluded the second round of Large and Long programs, which were oversubscribed by a factor of over seven. We are very happy with the high demand and will consider expanding the size of this scheme in the future. In addition, the Fast Turnaround program has been running steadily and smoothly since January.

In 2015B, we intend to fully merge the Fast Turnaround proposals into our regular observing queue (so far, we've allocated only dedicated nights), and offer it at Gemini South as well.

The 2015B Call for Proposals resulted in another pleasant surprise: GRACES — Gemini North's remote use of the Canada-France-Hawaii Telescope's ESPaDOnS spectrograph — was offered for the first time this year and the demand was huge! The Canadian and Brazilian communities requested GRACES for over 30 and 40 percent of their time, respectively. This led to an overall very balanced request of instruments in the North; while the Gemini Multi-Object Spectrograph still dominates the requests at Gemini South. But this did not prevent the Gemini Planet Imager from producing some very spectacular results in the last months! Several of these are covered in this issue (see the article starting on page 4 and the lead news item on page 8).

On the new instrument front, the four Gemini Instrument Feasibility Studies (GIFS) are now well underway ([URL](#)) and have been presented at the Toronto meeting. These will run until the end of the year — at which

point we'll be ready to follow up with the call to build the third instrument of the fourth generation (Gen4#3) based on these studies. See the article on page 17 of this issue for more information on the GIFS details.

Finally, the current situation on Maunakea deserves mention. Back in April, and again in June, the start of construction of the Thirty Meter Telescope was interrupted by protests on the Maunakea access road. The protests expanded statewide and resonated prominently on social media. These events re-launched the debate about culture and science on the mountain and much has been written in the press about this complex issue.

More important, both the observatories and the protestors engaged actively in a dialog around the future stewardship of Maunakea. Eventually, the Governor mandated ([URL](#)) the University of Hawai'i (tenant of the master lease for Maunakea) to prepare an action plan ([URL](#)). We, at Gemini, firmly believe that it is of utmost importance that both culture and science coexist in a balanced manner on the very special place that is Maunakea.

Markus Kissler-Patig is Gemini's Director. He can be reached at: mkissler@gemini.edu

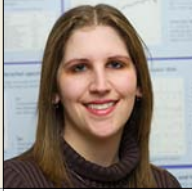

Valerie Rapson

First Likely Planets in a Nearby Circumbinary Disk

Recent Gemini Planet Imager (GPI) observations of V4046 Sagittarii provide the first strong evidence for ongoing planet formation around a young nearby binary star with a circumbinary disk. The GPI data reveal a distinct double ring structure within the disk that roughly corresponds to the orbital positions of Uranus and Saturn in our own Solar System. The discovery provides tests of giant planet formation theories.

Stars form when a region within a giant molecular cloud, composed mostly of hydrogen gas but including more complex molecules and dust, begins to gravitationally collapse. As it does so, individual clumps start to spin up and flatten out, creating young protostars surrounded by disks of gas and dust. It's within these circumstellar disks that planets, like those in our Solar System, will form.

To better understand how planets form, we can study the nearest young stars known to host planet-forming disks. The proximity of these star-disk systems allows astronomers to more easily image the disks and search for evidence of planet formation. In the not-too-distant future, we may even begin to directly image the newborn planets themselves.

Planet Formation Around Nearby Young Stars

Planet-forming circumstellar (protoplanetary) disks have been observed to extend out to radii of a few hundred astronomical units (AU) and are composed of a vast array of molecules, including diatomic hydrogen (H_2), carbon monoxide (CO), water (H_2O), and various carbon-bearing compounds found in our Solar System — such as hydrogen cyanide (HCN), cyanide

(CN), and ethynide (C_2H). Protoplanetary disks also contain carbonaceous and silicate dust grains, which coagulate over time, grow in size, and settle towards the disk midplane.

Present theories hold that giant planet formation in disks likely occurs via one of two mechanisms: core accretion or gravitational instability. In the core accretion scenario, ice-covered dust particles collide and stick together, growing into ever-larger rocky bodies; planetesimals form from this buildup of rocky material, and their collisions eventually build super-Earth-mass planetary “cores.” Such massive cores can then rapidly collect gas from the disk to form giant planets.

In contrast, the gravitational instability theory holds that planets form when a perturbation in the disk causes a large amount of disk material to collapse and form a planet essentially all at once. Hence, this rapid process is similar to that by which a young central star forms from its birth cloud.

Under either scenario, once a massive planet forms, co-orbiting material either accretes onto the planet or is accelerated radially in the disk via spiral density waves, which cause material approaching them to speed up — until they reach the perturbed regions, where they slow down and linger. These mechanisms result in ring-like or spiral structures in the disk characterized by sharp radial gradients in both surface density and particle size.

The predicted spiral and ring structures have indeed been observed in disks around young stars in nearby star-forming clouds with telescopes such as the Sub-Millimeter Array (SMA) and Atacama Large Millimeter Array (ALMA), and with near-infrared cameras on 8-meter-class telescopes, such as Subaru and Gemini. However, these observations are typically probing planet formation around young stars at orbital separations many times that of the gas giants in our Solar System.

Our team is interested in studying planet formation around young nearby stars within ~ 30 AU, where we can search for evidence for gas giant planet formation on scales similar to that of our Solar System. We do so by focusing on a handful of solar mass stars within ~ 300 light years (ly) of Earth that are surrounded by, and actively accreting material from, gas-rich circumstellar disks.

Target: V4046 Sagittarii

Our team has been closely scrutinizing one such star-disk system: V4046 Sagittarii (Sgr). Lying at a distance of just ~ 240 ly, V4046 Sgr is an extraordinary binary star system surrounded by a massive disk of gas and dust roughly 0.1 solar mass. With an age of only ~ 20 million years, this system provides us with an excellent opportunity to search for evidence of recent or ongoing planet formation. The V4046 Sgr system also offers an intriguing twist: Any planets spawned in its disk would have to orbit twin stars (both only slightly less massive than our Sun) separated by just ~ 9 solar radii.

Interestingly, the V4046 Sgr disk exhibits a central clearing out to ~ 30 AU (*i.e.*, $\sim 1/2$ arc-second) at submillimeter wavelengths. The presence of this inner “hole” suggests that one or more planets may be forming close to the central stars, carving out an opening within the disk (Figure 1 shows an artist’s



Figure 1.
Artist's impression of the binary star-disk system V4046 Sgr. Credit: NASA/JPL-Caltech/T. Pyle (SSC).

Figure 2.

Left: Total polarized intensity of the V4046 Sgr disk. Right: Total polarized intensity multiplied by r^2 , to account for dilution of incident starlight.

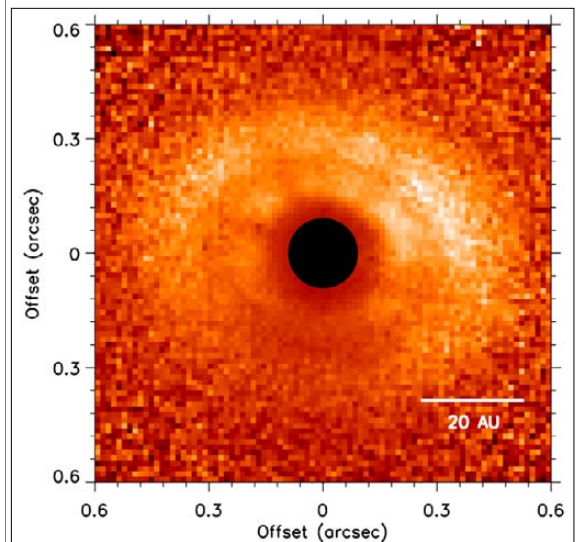
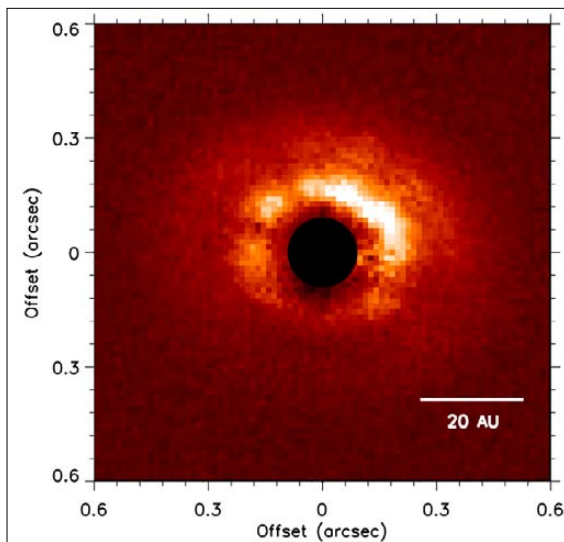

rendering of the V4046 Sgr disk based on these data).

On the other hand, our analysis of infrared observations from the Spitzer Space Telescope and Herschel Space Observatory suggests that the apparent “hole” at submillimeter wavelengths is actually partially filled with gas and dust. Since probing this inner-disk material directly requires imaging at resolutions near the diffraction limit of an 8-meter telescope, we turned to the new Gemini Planet Imager (GPI) on the Gemini South Telescope to achieve this extreme resolution.

GPI Imaging of V4046 Sgr

GPI is a state-of-the-art, near-infrared instrument dedicated to directly detecting and characterizing young, self-luminous exoplanets and the dusty circumstellar disks in which they form. GPI combines high-order adaptive optics, a diffraction-suppressing coronagraph, and an integral field spectrograph to obtain near-diffraction-limited images. GPI allows us to observe these targets with unprecedentedly short integration times of just a few minutes.

We obtained Early Science observations of V4046 Sgr with GPI in April 2014, using its coronagraphic+polarimetric modes to

trace light scattered off micron-sized (or smaller) dust grains in the disk. Our data consist of images through the J- and K2-band filters, at wavelengths of 1.24 and 2.25 microns, respectively.

Figure 2 shows the resulting images of the disk at J-band, which (thanks to the proximity of V4046 Sgr and the exquisite resolution and sensitivity of GPI) probe down to ~ 7 AU from the central binary at ~ 2 AU resolution. The left image is the total polarized intensity; the right image is total polarized intensity multiplied by the square of the deprojected distance from each pixel to the star (r^2) — to account for the fact that the light reaching the disk from the central star drops off as $1/r^2$.

The GPI images reveal a distinct double ring structure, with a bright inner ring centered at ~ 14 AU, and an outer halo extending out to ~ 45 AU. Two gaps appear in the disk: One between the two rings at ~ 20 AU, and one interior to the bright ring. These gaps roughly correspond to the orbital radii of Uranus and Saturn in our own Solar System. The gap/ring structure revealed by the GPI images of V4046 Sgr hence provides the first strong evidence for ongoing planet formation in a circumbinary disk within giant-planet-hosting regions similar to that of our Sun’s.

Dust Segregation

Further evidence for planet-building activity in the V4046 Sgr disk comes from a comparison of the GPI and SMA data (Figure 3). GPI imaging traces light scattered off small dust grains, which appear to prevail within 10-45 AU of the central stars. Data from the SMA traces thermal emission from larger centimeter- to millimeter-sized dust grains, revealing emission concentrated in a ring whose inner edge lies at ~ 30 AU. Thus, the GPI data confirm the earlier Spitzer and Herschel spectroscopic observations, which show that the gap seen at submillimeter wavelengths is indeed partially filled with small dust particles.

Modeling of planet formation in disks suggests that we should see this phenomenon of grain size segregation. When a gas giant planet forms in a disk, it creates local density waves that trap larger (mm- to cm-sized) particles outside the planet-forming regions of the disk. Smaller (micron-sized) grains freely pass through these pressure traps, resulting in strong dust particle size gradients.

Our comparison of the GPI and submillimeter imaging of the V4046 Sgr disk provides vivid evidence in support of these so-called “dust filtration” models by describing the structure of a circumbinary disk captured in the process of actively forming planets.

In summary, our GPI images appear to provide powerful tests of two planet-forming processes in the V4046 Sgr disk: (1) That one or more young giant planets following orbits similar to those of Saturn or Uranus have simultaneously carved out a disk gap and an inner disk hole; and (2) these gas-giant planets have generated large-scale density waves, resulting in dust particle filtration and segregation by size. Together these results offer two possible ways giant planets can form in debris disks around young, Sun-like stars.

In addition, this evidence for the presence of young giant planets around V4046 Sgr helps set essential constraints on simulations aimed at understanding the conditions in which giant planets might form around binary star systems — a theoretical question that is presently of intense interest, given the Kepler Mission’s detection of roughly 40 circumbinary planets to date.

What’s Next?

The Gemini Planet Imager has provided us with our first close look at some likely dynamic episodes in planet building activity within a circumbinary disk orbiting a young binary star system — especially in regions where gas giant planets are known to form around our Sun. Our team has subsequently obtained new time allocations with GPI to obtain deeper imaging of the V4046 Sgr disk. With these new observations, we hope to image the massive planets we suspect are forming, or have recently formed, in the disk.

We also plan to image other nearby young star-disk systems, to look for ring/gap features similar to those detected by GPI in the V4046 Sgr disk. Any additional results will further our understanding of the planet formation processes taking place in circumstellar disks orbiting young, Sun-like stars; they might also teach us something new about how gas giant planets formed in our own solar neighborhood.

Valerie Rapson recently completed her Ph.D. at the Rochester Institute of Technology. She can be reached at: vrapson@gmail.com

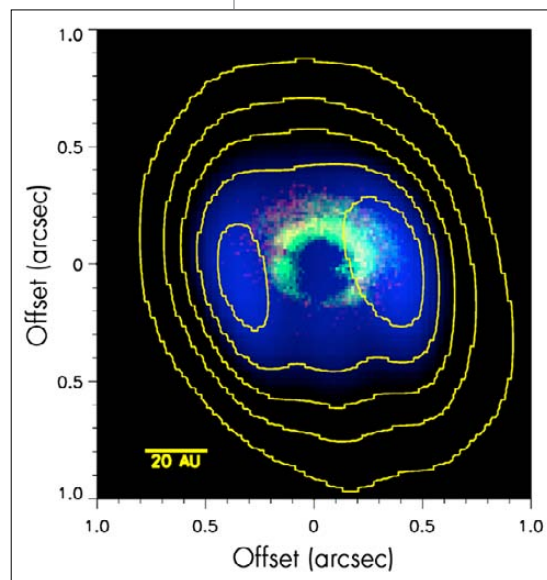

Figure 3.
Comparison of SMA data (blue shading and yellow contours) and GPI J (green) and K2 (red) data.



Nancy A. Levenson

Science Highlights

Figure 1.

This GPI image of HD 115600 in the H band (around 1.6 μm) clearly shows the disk that resembles the Kuiper belt of our own Solar System. The coronagraph blocks the light of the central star (at the position of the cross). The diamond marks the disk's center.

Recent scientific results from Gemini's users include a circumstellar disk that resembles our Sun's Kuiper belt, an enigmatic in situ formation of massive stars near the inhospitable center of our Galaxy, and evidence for two formation scenarios of Type Ia supernovae.

A Solar System Analogue, in Formation

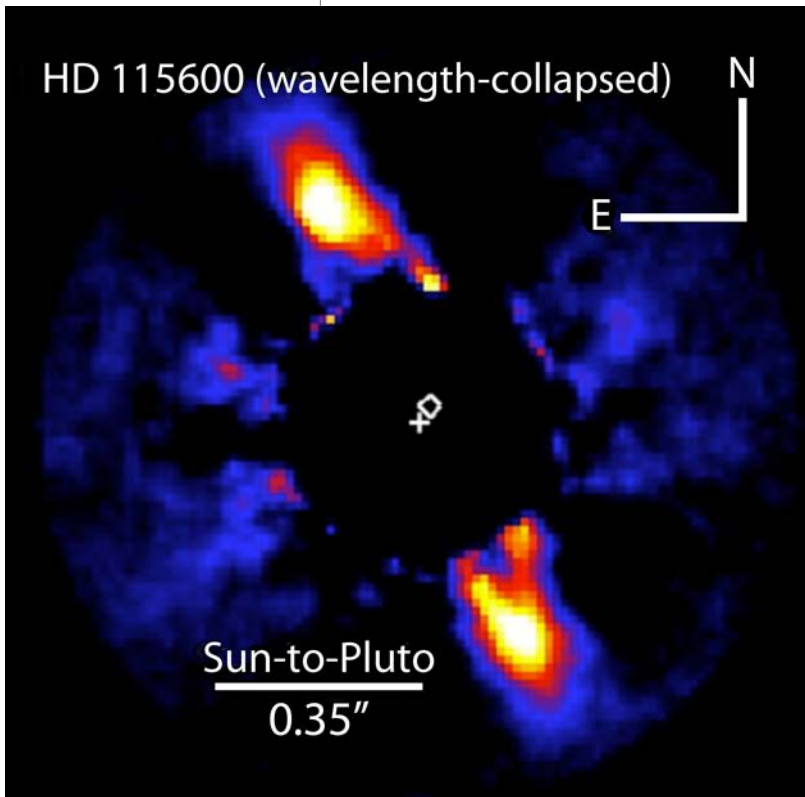

Observations using the Gemini Planet Imager (GPI) reveal an analogue of our own Solar System at an early stage of evolution. The debris disk, which resembles the Sun's "Kuiper belt," belongs to the young star HD 115600 — a star in the right environment (a massive OB association) to represent the site of the Sun's formation, with similar mass (1.4 to 1.5 M_{Sun}). Thayne Currie (National Astronomical Observatory of Japan) and collaborators have discovered this extrasolar debris disk in direct imaging, and they use the images and spectral information from GPI to determine its properties and possible unseen planets.

The eccentric structure of the emitting disk is consistent with the system being shaped by planets like those in our Solar System, at similar distances from the parent star. Many previously discovered systems have required unusual planets — super-sized Jupiters far from the disk's center — to create the observed structures. GPI's excellent resolution and

contrast allow probing more distant Sun-like systems than previously possible. GPI provides spectra along with the images, and the results are consistent with a significant water ice component. The complete work will be published in *The Astrophysical Journal Letters*, and a preprint is now [available](#).

Finding the Outer Edge of Young Stars Near the Galactic Center

The very center of the Milky Way Galaxy contains a number of massive stars — despite either the inhospitable environment for their formation in the vicinity of a supermassive black hole or the short time available for them to relocate there after formation elsewhere. New observations, obtained using the Near-Infrared Integral Field Spectrometer (NIFS) with laser and natural guide star adaptive optics, rule out at least one formation scenario (infall of a young stellar cluster) and help set the physical scale (0.5 parsecs (pc) or 1.6 light-years) for the extent of *in situ* formation.

Morten Støstad (University of Toronto) and colleagues take advantage of NIFS's spatial resolution, along with the simultaneous spectroscopy it provides, to classify the observed stars. The distribution of early-type (young) stars exhibits a sharp decline at a radius of about 0.5 pc, which is not a limit due to the observations.

This is the first spectroscopic study to significantly support earlier photometric observations of this effect. The finding is not consistent with the relocation of the stars from elsewhere. Instead, it suggests that they were formed in place, within the very center of the Galaxy. They could either mark the outer edge of a gaseous disk's stability or define the properties of colliding clouds that formed the stars.

The observed distribution of older (late-type) stars is consistent with earlier results showing a power law distribution that breaks at a similar radius, though lacking the very sharp drop-off the young stars show. Full results will appear in *The Astrophysical Journal*, and a preprint is now [posted](#).

Catching Supernovae in Advance

The earliest observations of supernovae can distinguish among their formation mechanisms. For Type Ia (SN Ia) events, the progenitor white dwarf may be pushed to become a supernova by accretion from a companion or by merger with another white dwarf. Besides being useful to account more fully for the end stages of stellar evolution, understanding the SN Ia mechanism is extremely important in their application to cosmology as standard (or standardizable) light sources.

Two new results find evidence for both of these SN Ia formation processes in different examples. In both papers, led by Yi Cio (California Institute of Technology) and Rob Olling (University of Maryland), observations from Gemini and other ground-based facili-

Figure 2. The NIFS image in the K band of one of nine regions analyzed. The field measures 3 arcseconds across and is located about 0.4 pc from the Galactic center. Symbols indicate spectral types: Blue triangles (early); green circles (late); black x's (ambiguous); and a foreground star (red square).

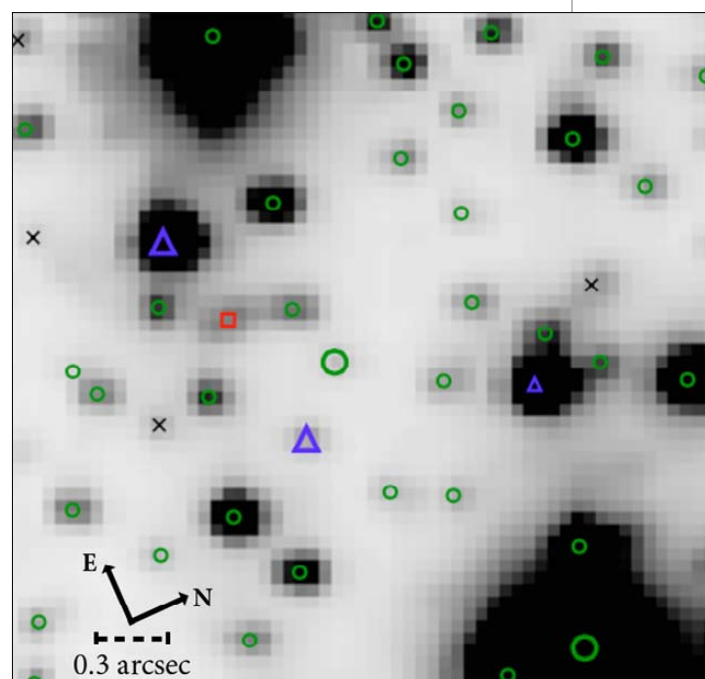

Figure 3.

Light curves of three of the doubly-degenerate SNe Ia, from the Kepler satellite (filled points and error bars), compared with models (blue lines).

ties provided key pieces of evidence that helped the teams classify the supernovae as SN Ia.

NASA’s Swift satellite triggered the first result. The ultraviolet emission it detected from the supernova was initially bright but decayed rapidly, which supports theoretical models of the “single degenerate” origin, where the companion star survives its collision with ejected material producing this emission. The Gemini observations were part of the Large and Long program that Mansi Kasliwal (also California Institute of Technology) leads, designed to obtain rapid spectroscopy using the Gemini Multi-Object Spectrograph (GMOS).

In contrast, the second paper shows three examples with no evidence for interaction with a surviving companion. This supports a “double degenerate” origin, which leaves no material for subsequent interaction. NASA’s Kepler satellite provided the first observations of these supernovae. The ground-based spectra, using GMOS on both Gemini North and South, showed that the hosts are passive galaxies at redshifts around 0.1. The two papers appear in the journal *Nature*, volume 521, pages 328 and 332.

Nancy A. Levenson is Deputy Director and Head of Science at Gemini Observatory. Her office is at Gemini South headquarters in La Serena, Chile. She can be reached at: nlevenson@gemini.edu

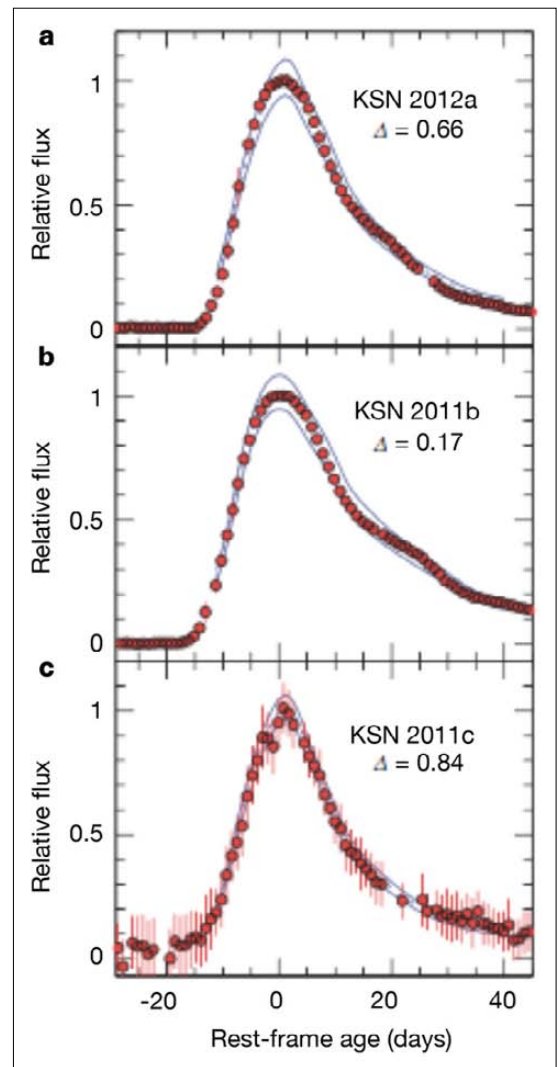



Contributions by Gemini staff

News for Users

Thermal noise in FLAMINGOS-2 has been returned to normal levels; fixes are on the way for the GMOS-South Hamamatsu CCDs; and Gemini mask-making software has been made more effective and user friendly for both Gemini South and North. Also, at Gemini North, an independent report on the dome shutter failures is due in July.

Guarding Against Future Shutter Failures

As Gemini Observatory and its users are both painfully aware, Gemini North lost a large amount of time in 2013B and 2014A due to two dome shutter failures. Since those events, we have carried out internal engineering studies, which resulted in a redesign of parts of the shutter drive gearboxes, and have procured spares (Figure 1) to speed the recovery process from a future similar failure, should one occur.

Also, we have engaged an external contractor to carry out a completely independent study of the dome and its mechanisms, to ensure that nothing is missed. Request for Bids for this consulting work was released in the early part of 2015, and Dynamic Structures was awarded the consulting contract in March.



Figure 1.
A fully assembled, spare shutter gearbox at Gemini North. Redesigned torque arms are at the top of the assembly.

A Dynamic Structures team visited Maunakea in late April to review the shutter system enclosure. They also took metrology data on the arch girders and top shutter in various positions. They are currently reviewing these data, and we expect their final report in July.

GMOS CCDs

The Gemini South Multi-Object Spectrograph (GMOS-S) Hamamatsu CCDs have suffered some significant issues since their installation in May 2015 — namely, saturated pixels affect significant patches of the channel they find themselves in. Now a fix (in the form of new-revision video boards) is on the way.

However, a further issue surfaced in April, involving an apparent smearing of charge in CCD1, particularly evident in nod/shuffle mode (Figure 3). Principal Investigators (PIs) were contacted and some workarounds have been devised, but the effect remains significant for many programs. Plans are in place to address the problem during June-July bright times (as this issue goes to press).

Meanwhile, plans for installation of Hamamatsu CCDs in the north are pending the outcome of the efforts under way in the south.

Mask-making Software Updated

Multi-Object Spectroscopy (MOS) is in high demand at both Gemini telescopes. Principal Investigators individually design the MOS masks for each science program using the Gemini Mask Making Preparation Software (GMMPS). Once checked, the physical masks are precisely cut using a laser milling machine in Chile (shared between Gemini, Cerro-Tololo International Observatory, and the Southern Observatory for Astrophysical Research).

After the installation of the new red-sensitive Hamamatsu CCDs in GMOS-S, which have different geometries and pixel scales compared to the detectors in GMOS-N, we recognized that the GMMPS source code had significant shortcom-

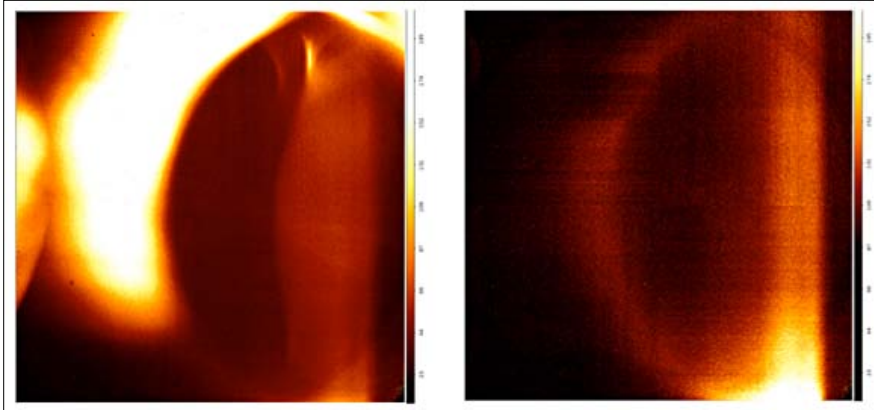

Figure 2.

“Before and After” images of FLAMINGOS-2’s thermal background in spectroscopy mode, with the baffle not correctly in place (left panel) and correctly in place (right panel).

FLAMINGOS-2 Stand-down Successfully Completed

In March, FLAMINGOS-2 was given a preventive maintenance stand-down, in which we fixed the gate valve baffle issue and installed a spectroscopic K-band filter. The gate valve baffle, stuck in place since late 2014, is now working well, returning the thermal radiation from the gate valve to nominal levels in spectroscopy mode (Figure 2).

Figure 3.

Charge transfer/smearing in Chip 1 of the GMOS-S CCD array. See the instrument status and availability pages for more details [here](#).

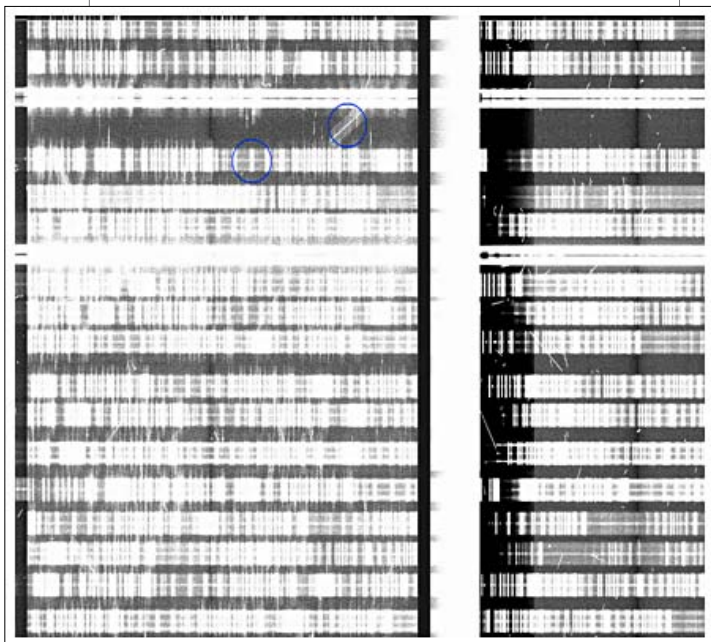

ings that prevented its use for creating masks for both GMOS instruments. In a concerted effort, the code was recently made less instrument-dependent. This fix also paves the way for mask creation for the MOS mode of the near-infrared FLAMINGOS-2 instrument, commissioning of which will begin this year. At the same time, all user interfaces were

made more transparent and user friendly. A series of internal consistency checks minimizes the number of submitted faulty mask designs, and a comprehensive user manual is available. All in all, this amounts to a significant overhaul for GMMPS, making it a more effective and user-friendly tool for mask creation (Figures 4-5)..

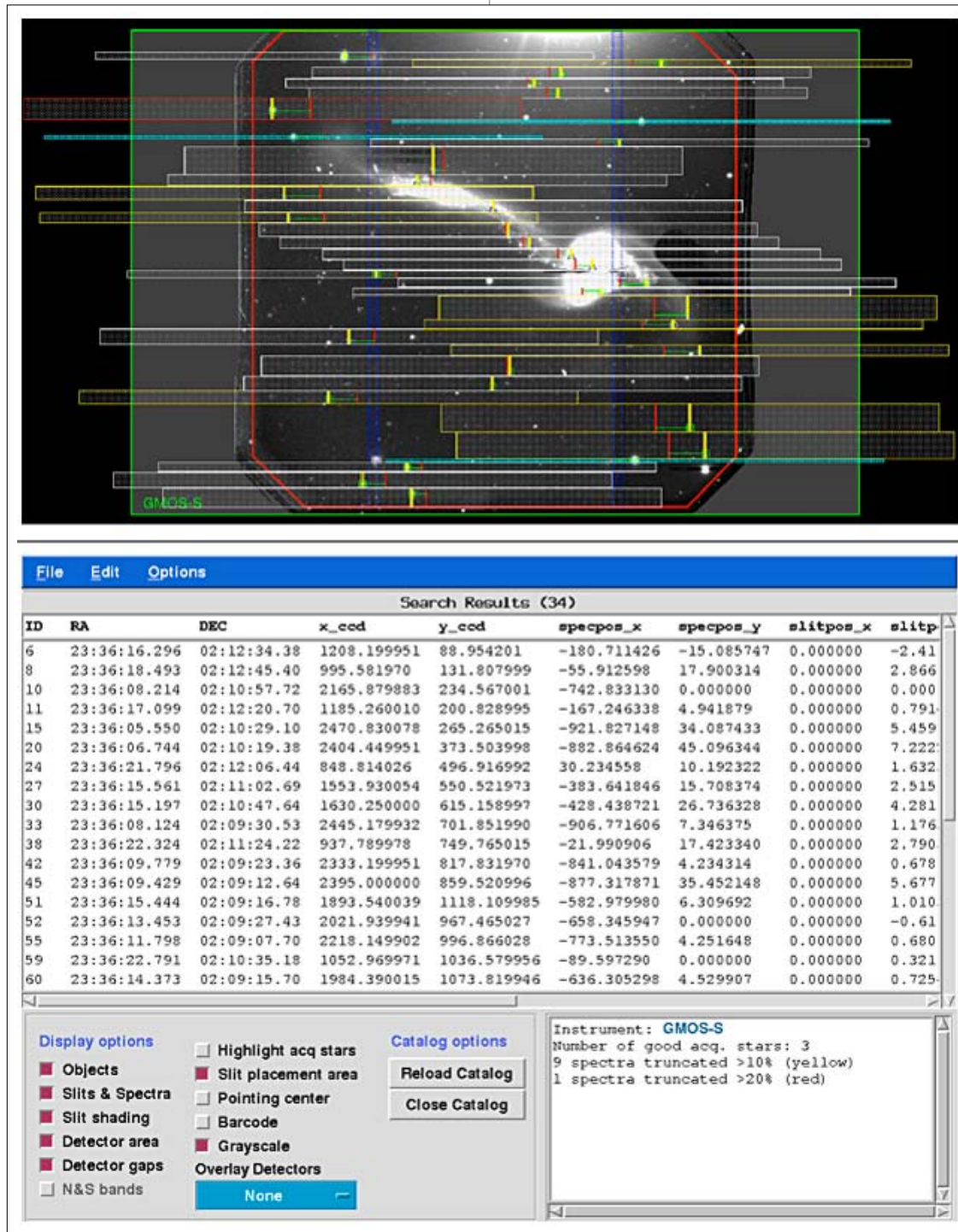

Figures 4-5.

Top: A final mask design overlaid over a GMOS-S pre-image. The large green rectangle displays the detector area where spectra are recorded. The thick red polygon indicates the field-of-view within which slits (small yellow vertical bars) may be placed. The spectral footprints are shown as filled horizontal rectangles. Bottom: The user interface that controls which elements are shown in the pre-image display. It also shows the number of valid acquisition stars and issues warnings if spectra are truncated by the finite detector geometry.

Figure 6.

GPI NRM “snowflakes” observed during the commissioning time in May 2015. Left: Raw data frame. Right: Power spectrum.

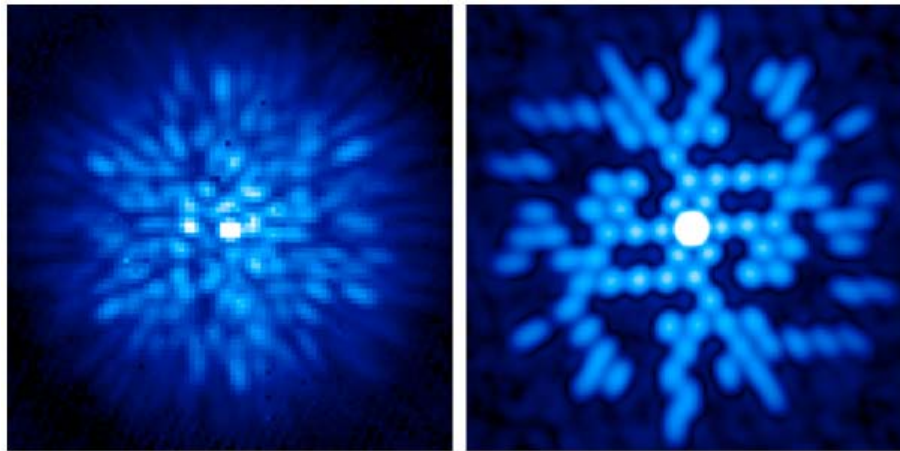

Non-redundant Masking with GPI

Commissioning of the Gemini Planet Imager (GPI) Non-Redundant Mask (NRM) mode was scheduled for late March, and coincided with the horrendous flooding event described below. Because of this, no data were taken. Since this mode was to produce some of the highest-contrast observations with GPI, we rescheduled a commissioning night in May. The team, led by Peter Tuthill and Alexandra Greenbaum, visited the telescope and obtained a night’s worth of useful data, which they are now working to reduce.

Future users will need to become familiar with the “snowflake” patterns produced when the seeing is good and the NRM mask is in place; two samples of this effect appear in Figure 6.

For the technically inclined, the raw image taken through the mask can be thought of as an interferogram — a pattern formed from fringes containing high spatial resolution; these cross the Airy disk diffraction pattern caused by the individual circular holes. The power spectrum image shows fringe power at 45 individual baselines; these correspond to each pair of holes in the mask and reveal the surprising degree of inherent order in the image.

Figure 7.

Aftermath of the major rainfall in Chile, March 2015

Data Center Re-engineering

Relatively unseen by the outside user, the summit data centers have been re-engineered over the past six months. The new data centers are split into hot and cold zones, producing significant energy savings. They also foster greater sustainability and cybersecurity.

Destructive Weather Event in Chile

Near the end of March, Chile suffered a freak storm that dumped many inches of rain on the high deserts and caused major flooding and destruction right down to the coast. Cerro Pachón was one of the affected areas. As a result, Gemini South lost power, communications, and nights of telescope time. Figure 7 shows some of the aftermath of the flooding. Thanks to the quick and effective work by the engineering staff, the telescope was back on line very shortly after the storm passed.



Washing the Gemini South Primary Mirror

A few times annually, the Gemini South primary mirror is subjected to an *in situ* wash in which the mirror, left in place on the telescope, is cleansed with specialized detergents to remove dust particles. The latest wash occurred in April; we show a picture of the process here (Figure 8). An *in situ* wash requires that we very carefully seal the bottom end of the telescope so that the instruments, science fold mirror, *etc.* do not get wet.

If you're wondering whether we do this in Hawai'i also, the answer is no, and it's because of geology. The wind-blown dust on Cerro Pachón is granitic, while that on Maunakea is light basalt. Granitic dust on the Gemini South primary does not fully come off with CO₂ cleanings, whereas basaltic dust on the Gemini North primary does. Therefore, given only carbon dioxide cleaning, reflectivity of the Gemini South primary would decrease more quickly than Gemini North's.

Figure 8.
Washing the Gemini South Primary Mirror in situ.

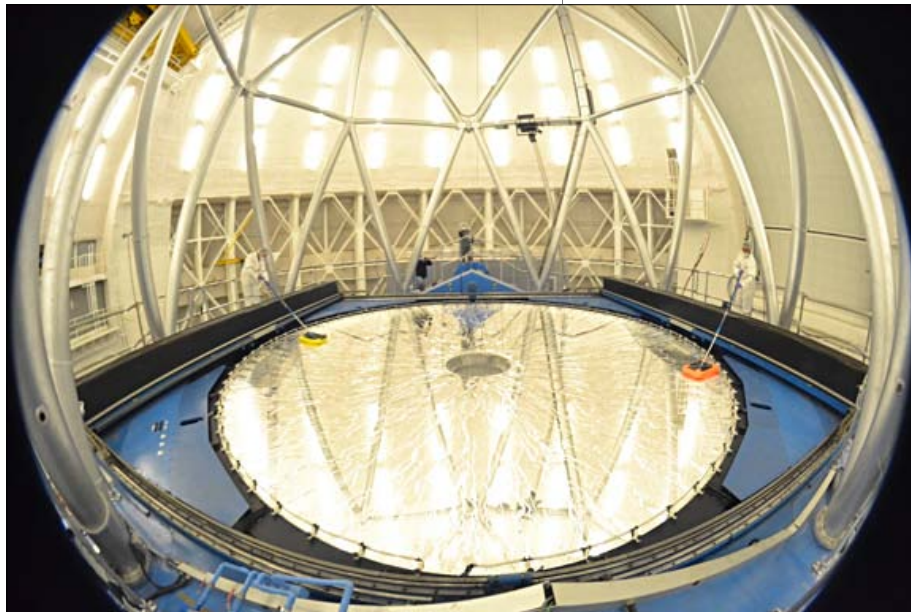



Contributions by Gemini staff

On the Horizon

As Gemini Observatory's remote access to the Canada-France-Hawai'i Telescope's high-resolution spectrograph (ESPaDOnS) nears scheduled operations, four independent instrument feasibility studies — to help Gemini determine the requirements for its next new generation instrument after GHOST — are approaching the deadline for final drafts of their study reports; summaries of each instrument study are provided here.

GRACES: Gearing Up for Operations

The Gemini Remote Access to CFHT's ESPaDOnS Spectrograph (GRACES) is ready for its first scheduled observing runs in 2015B. In the past quarter, the team made several improvements that make GRACES both more efficient and easier to operate. To improve ef-

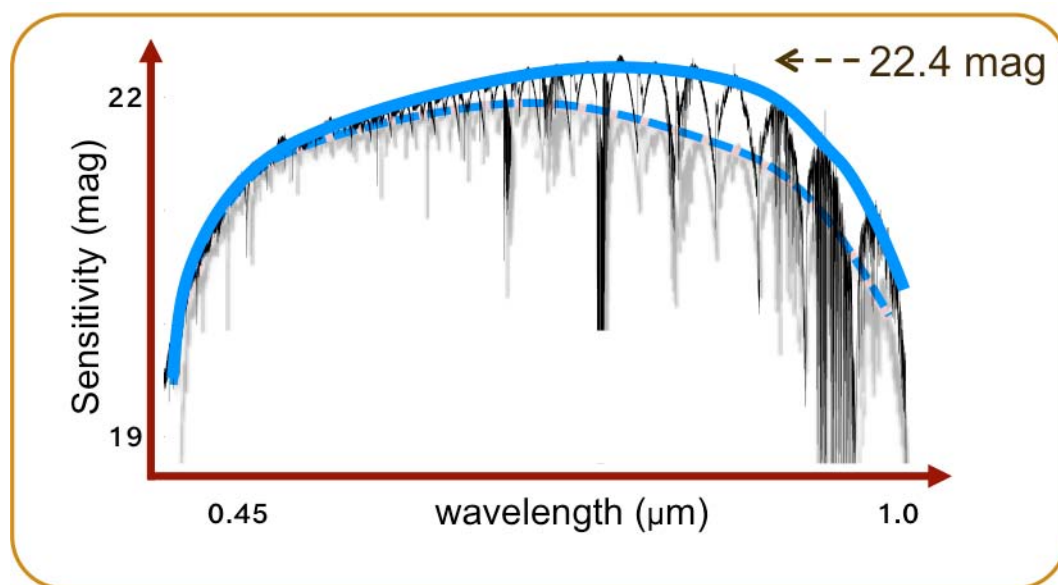
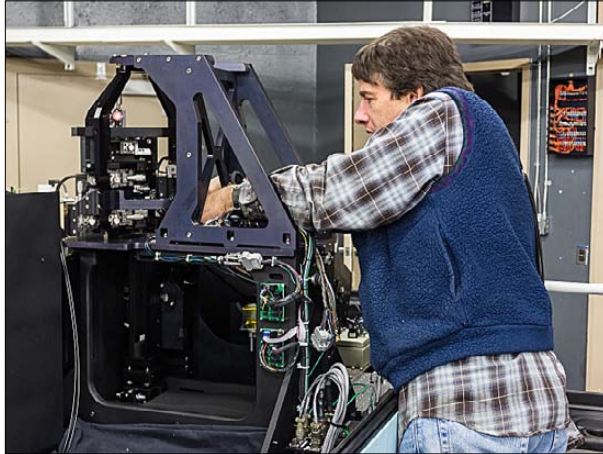

Figure 1. Comparison of the GRACES sensitivity as measured for the 2-fiber spectroscopic mode in May 2014 (dashed line) and in June 2015 (solid line). The sensitivity is defined as the magnitude of an object that would provide a signal-to-noise ratio of 1 after an hour of integration time. This figure illustrates GRACES performances improvements in the red part of the spectrum.

efficiency, the team recoated some key optics and redesigned one element that was vignetting the optical path). As a result, GRACES's efficiency is improved by an average of roughly 20 percent towards the red part of the spectrum. (See Figures 1 and 2.)



Small Projects Initiative

Gemini's instrumentation Department is also continuing with the Small Project initiative to leverage community interest and talent in keeping our current instruments competitive. We discussed ideas for these projects during the Toronto users meeting in June. A Request for Proposals will go out later this year.

GeMS Laser Procurement Accepted

In April, we completed a set of feasibility studies to explore the possibility of replacing the current Gemini Multi-conjugate adaptive optics System (GeMS) laser with one we could operate more often with reduced staff requirements. The results of these studies, using both internal and external resources, were positive, and the Gemini Board agreed at its last meeting that we should proceed to procure a new laser. We have started the contracting work and have made this effort a high priority project.

Gemini Instrument Feasibility Study (GIFS) Update

In April 2015, Gemini launched four independent instrument feasibility studies to help determine requirements for the next new Gemini instrument (also known as Generation 4#3, or Gen4#3) after GHOST. Each team's study will provide Gemini with a collection of science cases, top-level science and instrument requirements, and corresponding feasible instrument designs.

The team's efforts are guided by a set of principles provided by the Science and Technology Advisory Committee (STAC) [[viewable here](#)] that describe very high-level requirements for the Gen4#3 instrument. Once completed, the four studies will aid Gemini in creating the requirements for Gen4#3. We expect to release a Request for Proposals to design and build the instrument in the first half of 2016.

Each of the four feasibility study teams presented their ideas and work in progress at the recent Toronto 2015 Future & Science of Gemini Observatory meeting. The meeting also allowed each team to interact with many Gemini users and included a panel discussion that reflected on the coming needs for Gemini's next new instrument.

The teams will provide Gemini with draft study reports in mid-August 2015 and present their work in person a month later. Look for more detailed information shortly thereafter, both on the Gemini web pages ([view here](#)) and in future editions of *GeminiFocus*. The teams will submit the final reports in mid-October.

Summaries of the four team instrument studies follow:

Figure 2.
Greg Barrick (Canada-France-Hawaii Telescope) installing the GRACES receiver module in the ESPaDOnS spectrograph, incorporating some of the recently improved optics.

GEONIS

The Gemini Efficient Optical and Near-infrared Imager and Spectrograph (GEONIS) instrument concept is an efficient two-channel spectrograph and imager with wavelength coverage spanning 0.4 to 1.6 microns (μm). It is designed from the ground up as an observing system that uses new detectors, atmospheric dispersion correction, and a slit-viewing camera to maximize science collecting time and minimize overhead.

The astronomical landscape in the coming decade will be dominated by wide-field synoptic surveys, and GEONIS is driven to both classify and study transient events over a wide wavelength range in a single exposure. It also has broad reach across a variety of observational disciplines — from characterizing transiting exoplanets to pinning down the location of near-Earth asteroids, high redshift galaxies, and stars of unusual metallicity.

The study is being led by Nick Konidaris and managed by Dan Reiley, both at the California Institute of Technology. Main collaborators include astronomers at the University of Colorado Boulder, Penn State University, University of Toronto, the Jet Propulsion Laboratory, and the U.S. National Optical Astronomy Observatory.

For more information on the GEONIS study, please contact:

Nick Konidaris (PI): npk@astro.caltech.edu

Dan Reiley (PM): djr@astro.caltech.edu

MOVIES

The Montreal-Ohio-Victoria Echelle Spectrograph (MOVIES) instrument concept is a broad bandwidth, moderate resolution ($R \sim 3\text{ K} - 10\text{ K}$) dual arm optical and near-infrared (NIR) Echelle spectrograph that simultaneously covers at least 0.40 – 2.40 μm . It is supported by a rapid acquisition camera operating simultaneously in the optical and

near-infrared. Key additional features include rapid target acquisition, high stability, and a multi-band acquisition and guiding system. (See Figure 3.)

The primary science motivation for MOVIES includes spectroscopic follow up of the transient phenomena uncovered by facilities like the Large Synoptic Survey Telescope. Additional science drivers include studying the composition of stars and extrasolar planets and planetesimals.

The study is being led by Alan McConnachie and managed by Les Saddlemyer, both at the National Research Council of Canada Herzberg. Main institutional collaborators include Ohio State University and the Université de Montréal.

Figure 3.

Schematic of the MOVIES instrument layout.

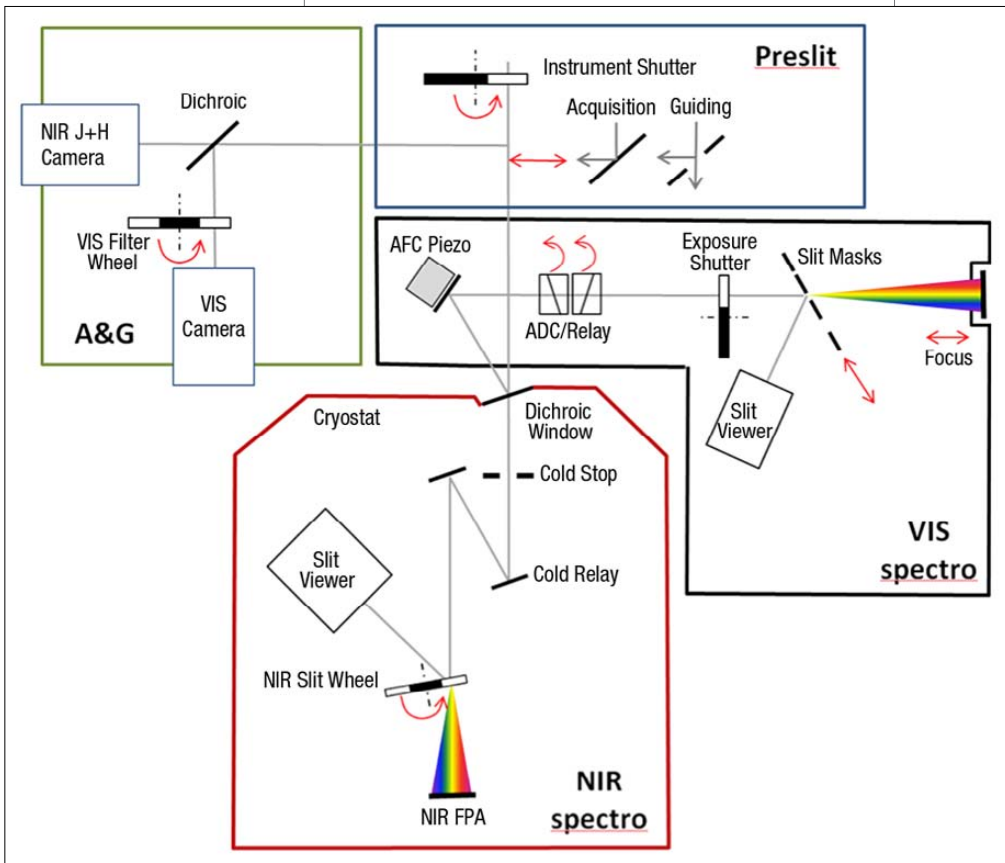

For more information on the MOVIES study, please contact:

Alan McConnachie (PI):

alan.mcconnachie@nrc-cnrc.gc.ca

Les Saddlemyer (PM):

leslie.saddlemyer@nrc-cnrc.gc.ca

GMOX

The Gemini Multi-Object eXtra-wide-band spectrograph (GMOX) instrument concept is a wide-band ($R \sim 5000$) spectrograph covering the entire optical/near-infrared spectrum accessible from the ground — from the U-band to K-band ($0.32 - 2.4 \mu\text{m}$) via five spectroscopic arms (Figure 3). Using existing micro-electromechanical systems technology, GMOX plans to exploit the exceptional image quality of the Gemini Multi-conjugate adaptive optics System (GeMS).

Prime GMOX science drivers include probing the high redshift universe from $6 < z < 10$ through deep spectroscopy of lensed galaxies and the re-ionization epoch. With its large

observable wavelength range and capability of operating in crowded fields, GMOX can also study ultraviolet/optical spectral features in a variety of regions, ranging from star formation at redshifts $1 < z < 3$ to stellar clusters in the Milky Way.

The study is being led by Massimo Robberto (Space Telescope Science Institute; STScI) and managed by Stephen Smee (Johns Hopkins University). Main institutional collaborators include the STScI and the Rochester Institute of Technology.

For more information on the GMOX study, please contact:

Massimo Robberto (PI): robberto@stsci.edu

Stephen Smee (PM): Smees@idg.jhu.edu

OCTOCAM

The (OCTOCAM) instrument concept is an 8-arm, multi-band imager and spectrograph, covering $0.37 - 2.35 \mu\text{m}$ with $R \sim 3000 - 4000$ and high time-resolution

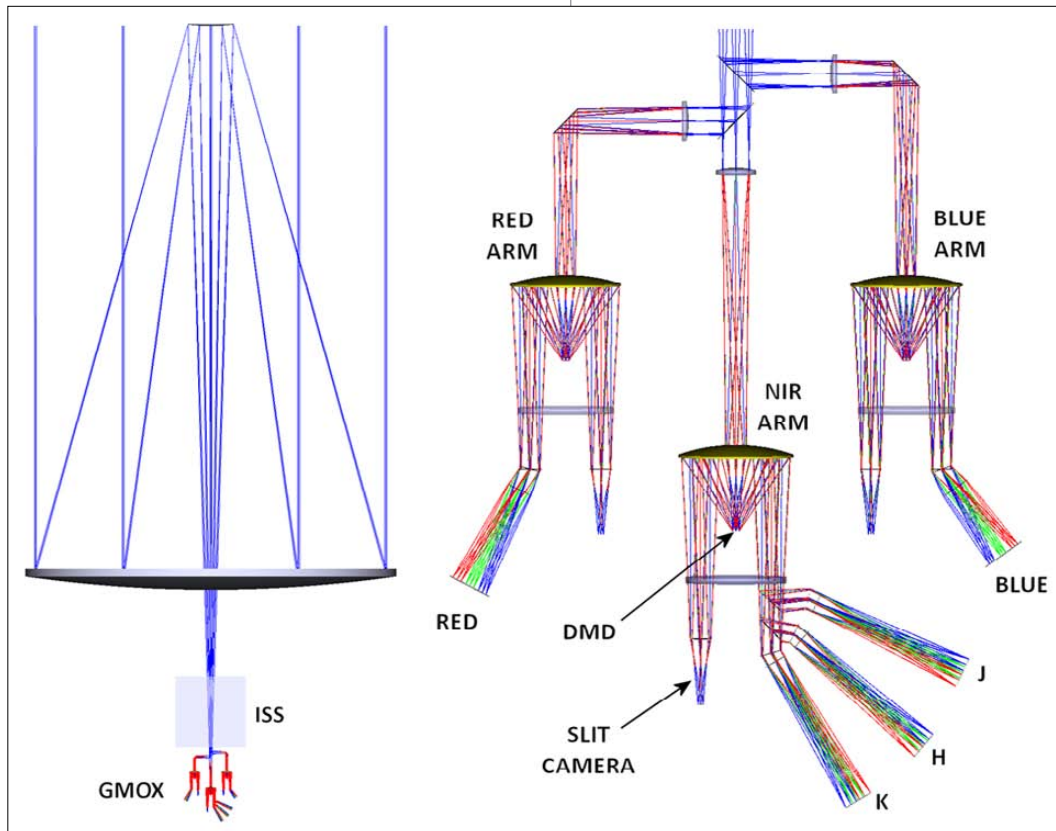

Figure 4. Optical layouts of a preliminary concept for GMOX. (a) GMOX on Gemini, shown beneath an ISS-sized cube for scale. (b) Schematic of a 3-arm arrangement for GMOX.

capabilities (Figure 5). The team will also study the potential science cases opened by including an additional integral field unit and a spectropolarimetric mode in the instrument design.

OCTOCAM's key science driver is the study of astronomical transients. Subsecond time resolution observations could allow the identification and characterization of extra-solar planets and their atmospheres through transits, the study of the internal structures of stars through asteroseismology, the study of the Solar System's history through trans-Neptunian object occultations, massive stellar explosions and outbursts, supermassive black hole environments, and the physical properties of jets.

The study is being led by Antonio de Ugarte Postigo (Instituto de Astrofisica de Andalucia; IAA-CSIC) and managed by Pete Roming (Southwest Research Institute) and Christina Thöne (IAA-CSIC). The project is being coordinated from the IAA-CSIC, with main institutional collaborators at the Southwest Research Institute, Fractal SLNE, and George Washington University.

For more information on the OCTOCAM study, please contact:

Antonio de Ugarte (PI): deugarte@iaa.es

Pete Roming (PM): proming@swri.edu

Christina Thöne (PM, Spain): cthoene@iaa.es

Figure 5.
A 3D view of the
OCTOCAM concept.

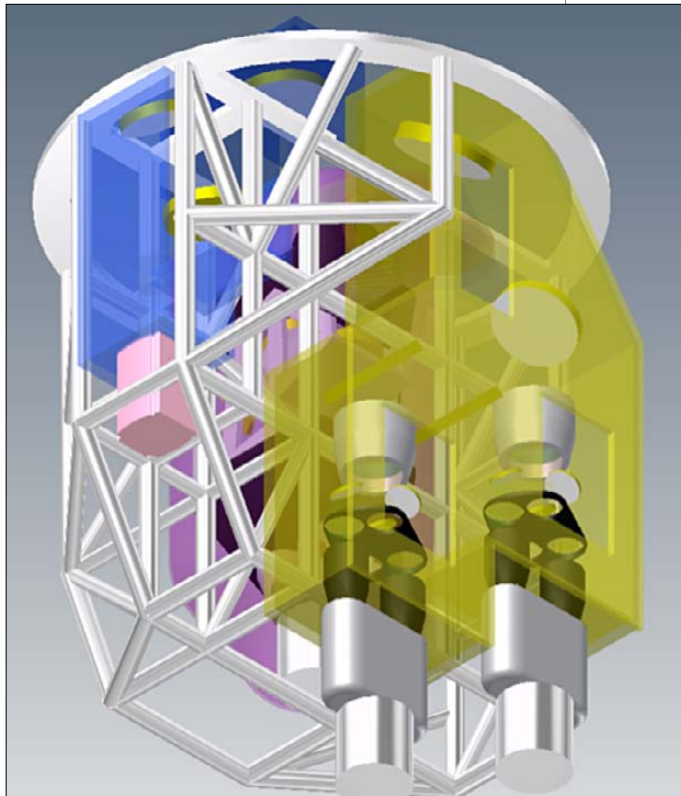

Seeing Where Stars Collide

Using the advanced adaptive optics system GeMS, on the Gemini South telescope, astronomers have imaged a beautiful stellar jewel-box — a tightly packed cluster of stars that is one of the few places in our Galaxy where astronomers think stars can actually collide.

Scientists have imaged a cluster of stars, heavily obscured by material in our Galaxy, where stars are so densely packed that it is likely a rare environment where stars can collide. “It’s a bit like a stellar billiards table, where the probability of collisions depends on the size of the table and on the number of billiard balls on it,” said Francesco R. Ferraro of the University of Bologna (Italy), one of the team members who used the Gemini Observatory to make the observations.

Liller 1 is a tight sphere of stars known as a globular cluster. Globular clusters orbit in a large halo around the center, or nucleus, of our Galaxy; many of the closer globular clusters are spectacular showpieces, even in small telescopes or binoculars. “This isn’t one of these showpieces, it is so obscured by material in the central bulge of our Galaxy that it is almost completely invisible in visual light,” observed Sara Sarachino of the University of Bologna and lead author on the paper. Indeed, Liller 1 is located at almost 30,000 light years from Earth, and only about 3200 light-years away from the center of the Milky Way — in one of the most inaccessible regions of our Galaxy, where thick clouds of dust prevent the optical light from emerging. “Only infrared radiation can travel across these clouds and bring us direct information on its stars,” commented Emanuele Dalessandro, also of the University of Bologna.

Figure 1.

Gemini Observatory near-infrared image of the globular cluster Liller 1 obtained with the GeMS adaptive optics system on the Gemini South telescope in Chile. This image is featured on the cover of this issue.

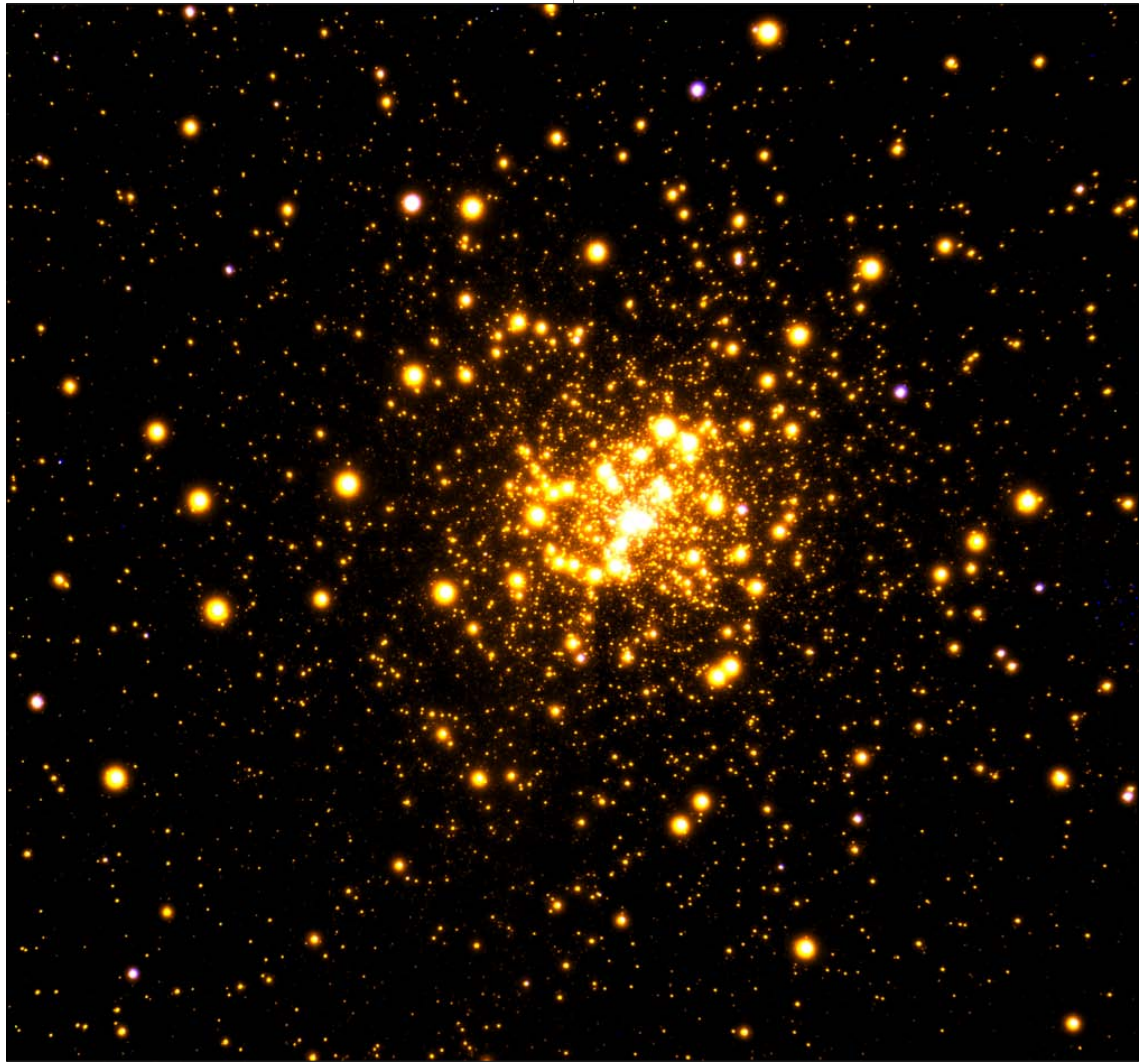

“Although our Galaxy has upwards of 200 billion stars, there is so much vacancy between stars that there are very few places where suns actually collide,” said Douglas Giesler of the University of Concepcion in Chile and Principal Investigator of the original observing proposal. “The congested overcrowded central regions of globular clusters are one of these places. Our observations confirmed that, among globular clusters, Liller 1 is one of the best environments in our Galaxy for stellar collisions.”

The unprecedented ultra-sharp view of the cluster reveals a vast city of stars estimated by the team to contain a total mass of at least 1.5 million suns, very similar to the two most massive globular clusters in our Galaxy: Omega Centauri and Terzan 5.

Geisler’s team specializes in the study of globular clusters near the center of the Milky Way, while Ferraro’s team is adept at the reduction of infrared data on globular clusters. Both groups worked together to obtain the beautiful and detailed observations of Liller 1 with Gemini.

The observations of the tightly packed cluster used Gemini Observatory’s powerful adaptive optics system at the Gemini South telescope in Chile.

A technical jewel named GeMS (derived from “Gemini Multi-conjugate adaptive optics System”), in combination with the powerful infrared camera Gemini South Adaptive Optics Imager (GSAOI), was able to penetrate the dense fog surrounding Liller 1 and to

provide astronomers with this unprecedented view of its stars.

This has been made possible thanks to the combination of two specific characteristics of GeMS: First, the capability of operating at near-infrared wavelengths (especially in the K pass-band); second, an innovative and revolutionary way to remove the distortions (blurriness) that the Earth's turbulent atmosphere inflicts on astronomical images.

To compensate for the degrading effects of the Earth's atmosphere, the GeMS system uses three natural guide stars, a constellation of five laser guide stars, and multiple deformable mirrors. The correction is so fine that astronomers are provided with images of unparalleled sharpness.

In the best K-band exposures of Liller 1, stellar images have an angular resolution of only 75 milliarcseconds, just slightly larger than the theoretical limit (known as the diffraction limit) of Gemini's 8-meter mirror. This means that GeMS almost perfectly corrected Earth's atmospheric distortions.

The international research team published the results in the June 15 issue of *The Astrophysical Journal* (volume 806, page 152). The astro-ph version of the article can be found [here](#).

The results achieved on Liller 1 have been so important that the research team is currently expanding their work to other globular clusters, which promise to deliver even more exciting science.

Background: Stellar Collisions

Stellar collisions are important because they can provide the key to understanding how certain exotic objects, which cannot be explained by the passive evolution of single stars, originate. "Blue Stragglers,"

for instance, are old stars that mysteriously appear younger than they should be; these exotic stars may be formed by nearly head-on collisions that cause the stars to merge, mixing their nuclear fuel and restoking the fire of the nuclear fusion. But collisions can also involve binary systems, with the effect of shrinking the initial size of the system, promoting the two components to interact and producing a variety of objects like low-mass X-ray binaries, millisecond pulsars, etc.

In particular, millisecond pulsars are old neutron stars in a binary system whose rotation periods have been reaccelerated to milliseconds by matter accreting onto them from a companion star. Astronomers suspect that Liller 1 harbors a large population of these exotic objects. Although no millisecond pulsar has been directly observed up to now, the detection of intense gamma-ray emission (the most intense detected so far from a globular cluster) suggests a large hidden population. The Gemini observations confirm that this is possible.

"Indeed, our observations confirm Liller 1 as one of the best 'laboratories' where the impact of star cluster dynamics on stellar evolution can be studied: It opens the window to a sort of stellar sociology study, aimed at measuring the impact of the reciprocal influence of stars when they are forced to live in conditions of extreme crowding and stress," concluded Ferraro.

Additional information can be found at <http://www.cosmic-lab.eu/Cosmic-Lab/Liller1.html>



The Gemini Observatory is operated by the Association of Universities for Research in Astronomy, Inc., under a cooperative agreement with the National Science Foundation on behalf of the Gemini Partnership.



United States



Canada



Australia



Argentina



Brazil



Chile

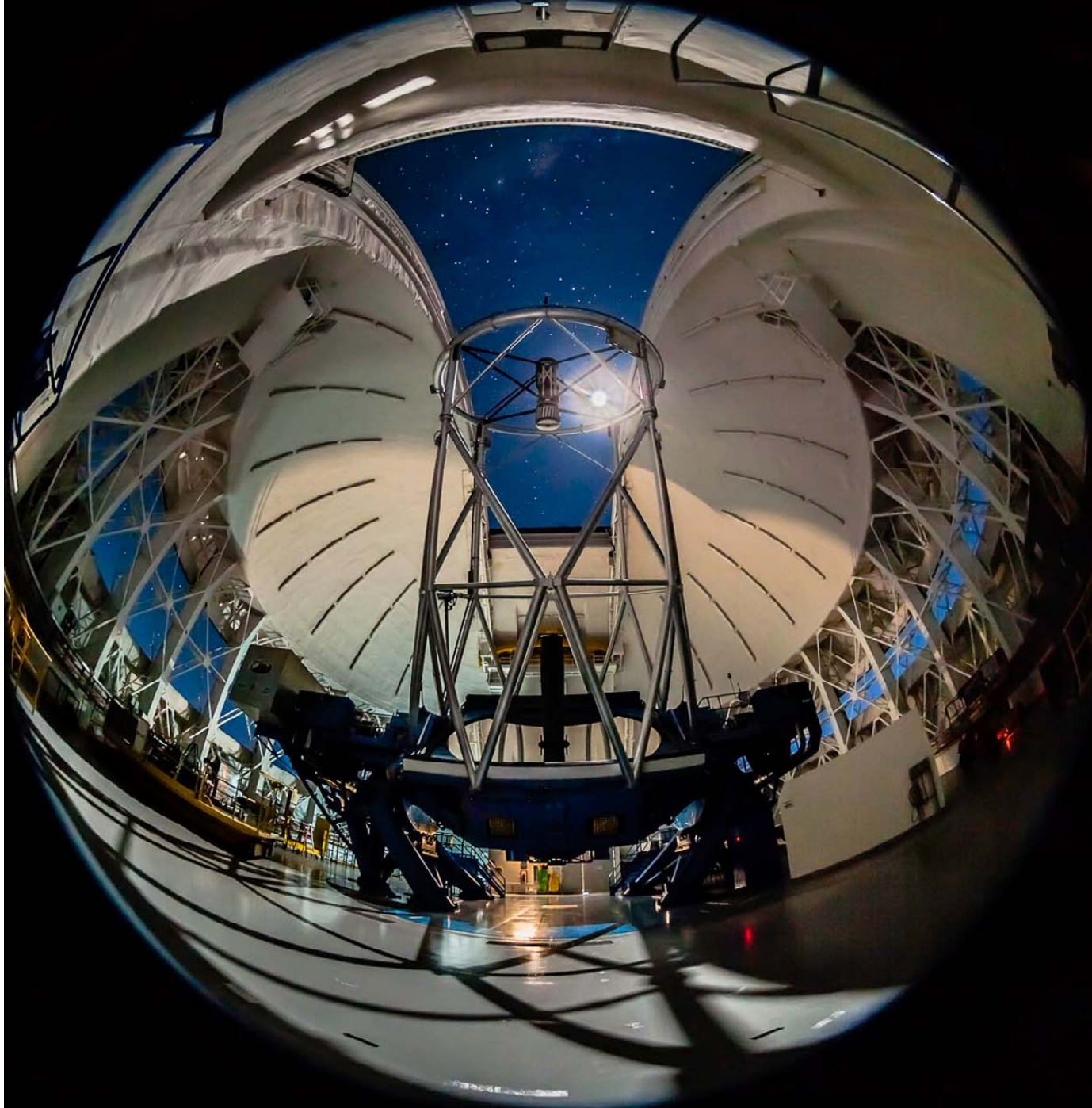

The Gemini South telescope, illuminated by the full Moon, shortly before propagation of the GeMS laser. Gemini photo by Manuel Paredes.

Gemini Observatory
670 N. A'ohoku Place
Hilo, HI 96720, USA

