

Gemini Focus



Publication of the Gemini Observatory / April 2019



1 Director's Message

Jennifer Lotz

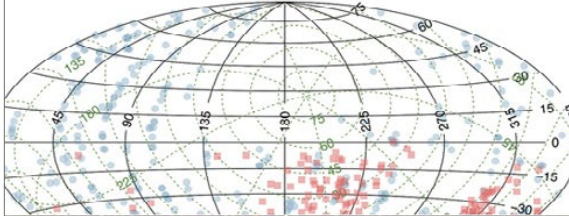

3 Making Good Use of Bad Weather: Finding Metal-poor Stars Through the Clouds

Vinicius Placco

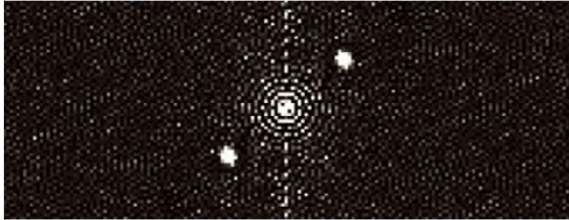

8 Science Highlights

John Blakeslee

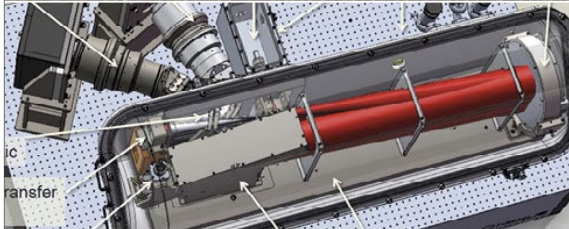

13 On the Horizon

Gemini staff contributions

16 News for Users

Gemini staff contributions

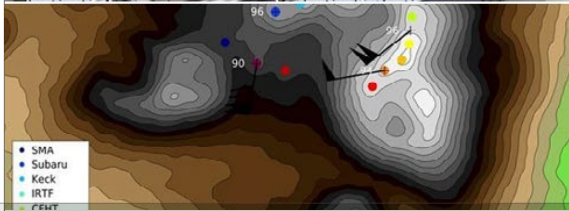

21 Gemini Outreach Programs Sparkle in Both Hemispheres

Manuel Paredes and Alyssa Grace

ON THE COVER:

Gemini GeMS+GSAOI J, K color composite image of HP 1, a globular cluster just 3° away from the Galactic Center that is a "fossil relic" of the Galactic bulge's early formation. The work, led by Leandro Kerber of the Universidade de São Paulo and Universidade Estadual de Santa Cruz in Brazil, is featured in this issue's Science Highlights starting on page 8.

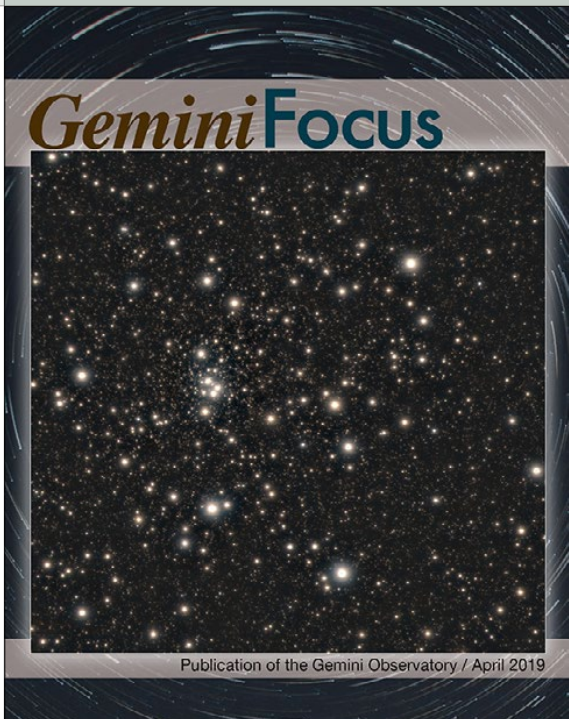

GeminiFocus April 2019

GeminiFocus is a quarterly publication of the Gemini Observatory

670 N. A'ohoku Place

Hilo, Hawai'i 96720, USA

Phone: (808) 974-2500 / Fax: (808) 974-2589

Online viewing address:

<http://www.gemini.edu/node/27>

Editor: Peter Michaud

Associate Editor: Stephen James O'Meara

Designer: Eve Furchgott/[Blue Heron Multimedia](#)

Any opinions, findings, and conclusions or recommendations expressed in this publication are those of the author(s) and do not necessarily reflect the views of the National Science Foundation or the Gemini Partnership.



Jennifer Lotz

Director's Message

Riding the Waves to New Heights at Gemini

It's been an interesting few months at Gemini, especially between facing the challenges of the US government shutdown and a significant earthquake in Chile. We've also interacted with the community at the American Astronomical Society and Korean User meetings, while making continued progress on adaptive optics (AO), time-domain astronomy, and visiting instrument initiatives.

Despite the ups and downs of the past few months, Gemini Observatory and our users have continued to collect photons and produce amazing science, as evidenced in Science Highlights starting on page 8 of this issue. With Gemini, astronomers have confirmed the age and distance of one of the oldest star clusters in our Galaxy; measured the size of the trans-Neptunian object Varth, and calculated the mass of the brightest quasar detected at a redshift greater than 5.

On January 19th, a magnitude 6.7 earthquake (with an epicenter just 60 kilometers southwest of Cerro Pachón) rocked Gemini South. This major shake-up occurred during a GeMS/GSAOI run, with a number of staff on the summit running the multi-conjugate adaptive optics laser system. Fortunately, we had no injuries at the summit or La Serena Base Facility. Gemini engineering and base facility leads responded very quickly and found no major damage at either site. The engineering team also completed a systematic evaluation of the telescope and found that the earthquake had affected several actuators on the primary mirror, which they successfully replaced. Thanks to our efficient team, Gemini South was back on sky, making science observations just five days after the earthquake. On March 13th, Gemini North experienced its own 5.5-magnitude earthquake, ceasing telescope operations for the night. After a similar checkout by the day crew, Gemini North was up and running the next night.

In February, I was able to visit Korea for the first time to attend the K-GMT Program Users Meeting, which was held over two and a half days at the Korea Astronomy and Space Science Institute (KASI) in Daejeon. The event featured many fabulous talks by the Korean astronomy community. I was particularly impressed by the excellent student presentations. Korean astronomers have been conducting exciting research at both at both Gemini and the Multi-Mirror Telescope

in Arizona. The science (which includes data from the visiting high-resolution, near-infrared spectrograph, IGRINS) ranged from high-red-shift Lyman-alpha blobs to shock physics in the Orion Nebula.

I also toured the KASI instrumentation laboratory where work on IGRINS2 — the Gemini facility instrument successor to IGRINS — is already underway. Finally, we began planning for the next Gemini Science Meeting, to be held in Korea in the summer of 2020, in celebration of Gemini Observatory's 20th anniversary.

Meanwhile, work on our new Gemini in the Era of Multi-Messenger Astronomy (GEMMA) program is ramping up. This exciting six-year project has three main aims: 1) to build a new multi-conjugate adaptive optics (AO) facility at Gemini North (GNAO), while updating our AO real-time computing system for both telescopes; 2) to develop the software infrastructure needed for multi-messenger and time-domain astronomy in the era of Laser Interferometer Gravitational-Wave Observatory (LIGO) and Large Synoptic Survey Telescope (LSST) research; and 3) to convene workshops on communication and outreach focused on how to promote the message of multi-messenger astronomy.

We convened technical advisory and science advisory AO working groups to refine our technical and science requirements for GNAO, drawing on a broad base of expertise from the AO and Gemini partner communities. Many thanks to the AO working group chair, Julian Christou (Large Binocular Telescope Observatory), and the GNAO science team chair, Suresh Sivanandam (University of Toronto). One of the primary goals of the new GNAO system is to provide rapid-response high spatial resolution data for time-domain science programs; these science-use cases are described in a 2020 Decadal Survey on Astronomy and Astrophysics (Astro2020) white paper, "Probing the Time Domain with High Spatial Resolution," led by Gemini's Chief Scientist John Blakeslee.

We also convened our time-domain astronomy policy group, chaired by Abi Saha (National Optical Astronomy Observatory), which is tasked with advising Gemini on time allocation policies for Target of Opportunity and other time-domain astronomy programs in the era of LIGO and LSST. This includes reviewing and advising the Observatory on processes to maximize the science return from transient object follow-up, while protecting the completion rates of programs targeting non-transient sources. It also includes broader policy considerations such as the exchange or pooling of observing time while participating in a transient follow-up network such as the Astronomical Event Observatory Network (AEON). The final recommendations of this group will be reported to the Gemini Board by November 2019.

For 15 years, Gemini Observatory has led the *Journey Through the Universe* outreach program in Hawai'i. Each March, this program brings together astronomers, K-12 students, observatory staff, teachers, and community leaders on the Big Island for a week of activities that help foster STEM education and learning. This year's events included classroom visits by over 70 astronomy professionals, portable planetarium visits to pre-kindergarteners through first graders, and career panels at Wai'ākea and Hilo High Schools. (See [local news coverage here](#).)

Journey Through the Universe and *AstroDay Chile* are both highlighted starting on page 21. Both of these programs are important bridges between today's astronomers and the present and future Hawai'i and Chile communities.

I look forward to the exciting times ahead for the Observatory and the astronomical community, as we steer Gemini into the future where new and exciting discoveries await.

Jennifer Lotz is the Gemini Observatory Director. She can be reached at: jlotz@gemini.edu



Vinicius Placco

Making Good Use of Bad Weather: Finding Metal-poor Stars Through the Clouds

The Gemini telescopes played a key role in identifying low-metallicity stars in the Galaxy by gathering medium-resolution spectroscopic GMOS data for 666 bright ($V < 14$) stars under poor weather conditions. In-depth studies of these stars provide a unique opportunity to witness not only the chemical and dynamical evolution of the Milky Way but also to identify and distinguish between a number of possible scenarios for the enrichment of star-forming gas clouds in the early Universe.

Low-metallicity stars are the Rosetta Stones of stellar astrophysics. Encoded in the atmosphere of these low-mass, long-lived relics are the signatures of nucleosynthetic processes, by which the first light elements were cooked up; this could have occurred as early as a few tens of millions of years after the Big Bang. The first generation of stars to be born in the Universe were formed (mostly) out of hydrogen and helium. These are thought to be massive (tens to hundreds of solar masses), short-lived, and to end their lives in an explosive event that would seed the up-to-then chemically pristine Universe with most of the chemical species we know today. By studying the mass distribution of these so-called Population III (Pop. III) stars it is possible to constrain models for the chemical evolution of the Universe at high-redshifts and the formation and evolution of our Galaxy. However, most (if not all) of the Pop. III stars are long gone, and the only way to infer their existence is by observing the low-mass stars formed right after.

Extremely Metal-poor Stars: Windows into the Early Universe

The only way to understand and characterize the first generation of stars is to look for their direct descendants that would still be alive today: second-generation low-mass, low-metallicity stars. A subset of these, the Extremely Metal-Poor (EMP; $[Fe/H] < -3.0$) stars, with iron abundances of 1/1,000 of the solar value, are believed to carry in their atmospheres the chemical fingerprints of the evolution of as few as one Pop. III massive star. Apart from the very low iron abundance, the majority (more than 60%) of the observed EMP stars show a very strong molecular carbon signature in their optical spectrum. Such high carbon abundances are one of the expected yields of the final stages of evolution of zero-metallicity Pop. III stars and can help trace back the nature of the first stars in the Universe.

Finding the Needle in the Haystack

Identifying such pristine objects is a challenging endeavor. EMP stars are intrinsically rare (less than 30 stars identified to date with $[Fe/H] < -4.0$) and can only be properly characterized as such via spectroscopic studies. In addition, metal-poor stars are generally

found in higher fractions in the halo populations of the Galaxy, making most of them faint and "expensive" in terms of telescope time. Thus, it is important to have reliable selection criteria in the search for the brightest metal-poor star candidates for high-resolution spectroscopic follow-up.

Since changes in metallicity affect the colors in optical wavelengths in predictable ways, we pre-selected a number of such candidates from broadband or narrowband photometry. Even though these methods can successfully identify metal-poor star candidates, they become more and more uncertain as metallicities decrease. As a result, medium-resolution ($R = \lambda/\Delta\lambda \approx 1,500$) spectroscopy becomes a valuable tool not only for pre-selection of targets to be followed-up in high-resolution ($R \approx 30,000$) but also for parameter determination and stellar population studies.

Recently, our team published two studies in *The Astronomical Journal* (Placco *et al.*, 2018; Placco *et al.*, 2019), aiming to increase the inventory of EMP star candidates observed with medium-resolution spectroscopy. We observed these stars over the course of seven semesters (from 2014A to 2017A) with a variety of telescopes, including the Gemini North and South telescopes, the Southern Astrophysical Research telescope, Kitt Peak National Observatory's Mayall telescope, and the European Southern Observatory's New Technology Telescope. In total, 2,551 stars were observed.

We selected the (bright) candidates from two sources — the RAdial Velocity Experiment (RAVE) and the Best & Brightest Survey (B&B) — and used the Gemini North and South telescopes to observe 666 stars out of the 2,551. Figure 1 shows the distribution of equatorial and

Figure 1.
Equatorial and Galactic coordinate distribution of the stars observed with Gemini North and Gemini South in poor weather conditions.

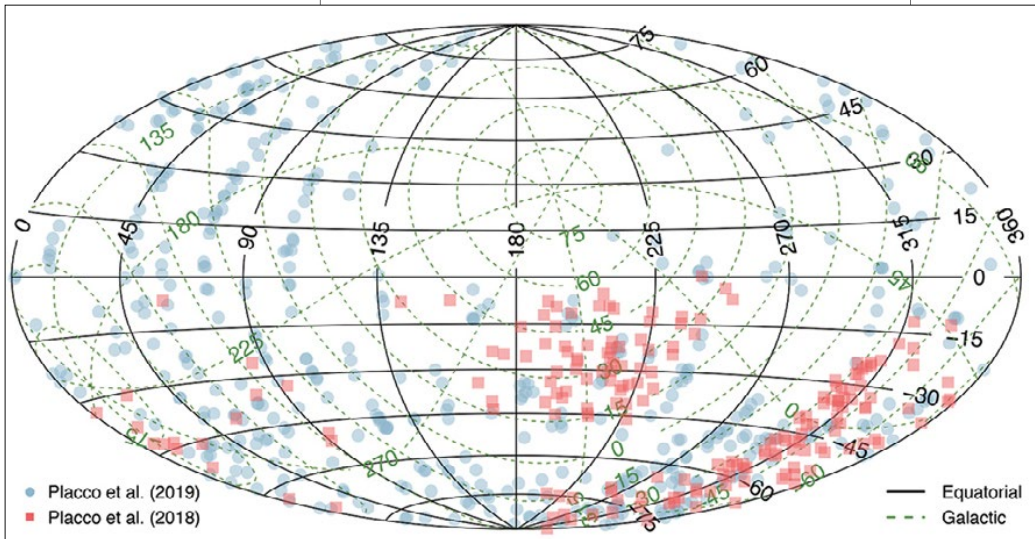

Galactic coordinates for the Gemini targets, color-coded by catalog. All of these spectra, interestingly, were gathered exclusively as part of the Poor Weather proposal cycle offered by the Gemini Observatory.

Big Eyes and Cloudy Nights

The targets selected from the RAVE and B&B catalogs were bright enough to be observed under poor, but usable, conditions, as part of the Poor Weather programs at Gemini. Such programs are executed only when nothing in the regular queue is observable and hence considered "weather loss" for time accounting purposes. The targets followed-up as part of this effort had no observing condition constraints (CC = Any, IQ = Any, SB = Any/Bright, and WV = Any), and spectra were taken using the Gemini Multi-Object Spectrograph (GMOS; North and South) B600 gratings and 1-arcsecond slits.

Figure 2 shows the total counts at 4000 angstroms in the observed spectra as a function of the visual magnitude of the stars. The size of the symbols is proportional to the

exposure time for each object, in seconds. It is interesting to note the large spread in counts for stars with similar exposure times in a narrow range of magnitudes (e.g., blue filled circles at $V \sim 13.5$). Similarly, there are cases where it took up to four times longer to gather the same counts for stars with similar magnitudes (e.g., red filled squares at $V \sim 12.5$ and Counts $\sim 1,000$). These are telltale signs of the highly variable weather conditions (mostly image quality and cloud cover) in which these stars were observed.

In total, seven GMOS Poor Weather programs were executed (three in the North and four in the South) spanning four semesters (from 2015A to 2016B). Those programs had 310 hours of allocated time. By adding all the exposure times, there were about 89 hours of on-target observations for the 666 stars, averaging about 8 minutes per exposure. Adding ~ 12 minutes for acquisition and calibrations, these were 20-minute observing blocks, giving an average of three stars per hour. As a result, assuming 666 targets took 222 hours of observing time, the efficiency was around 72%, meaning that only 28% of

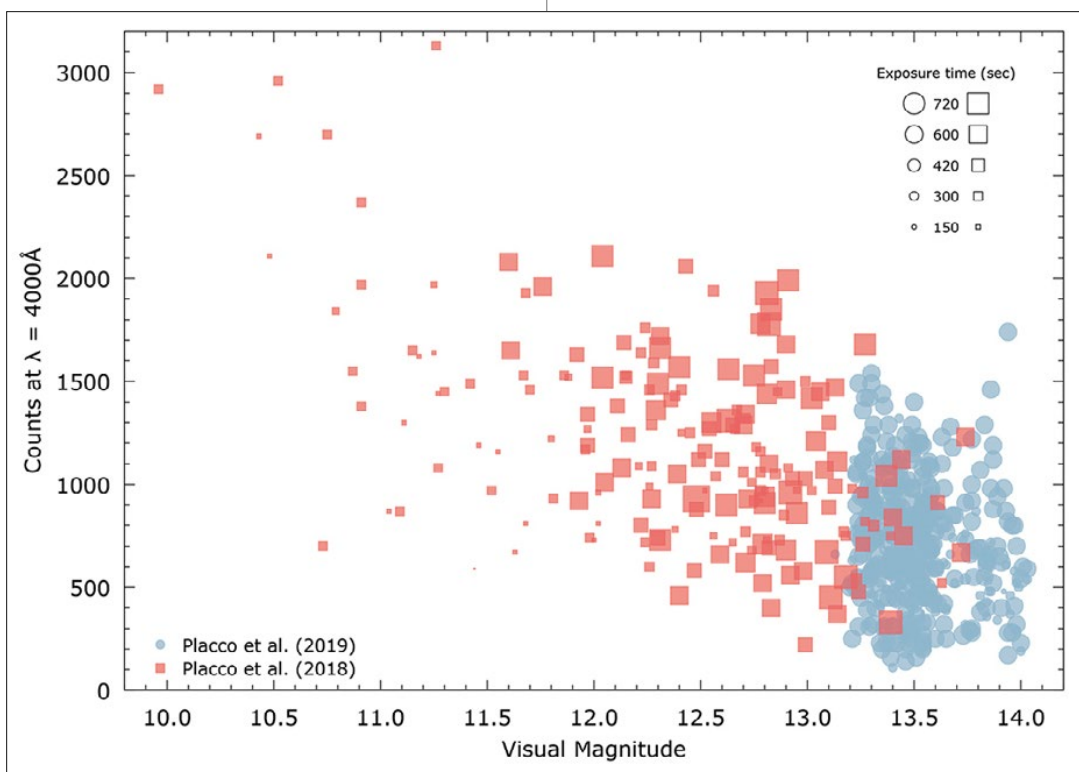
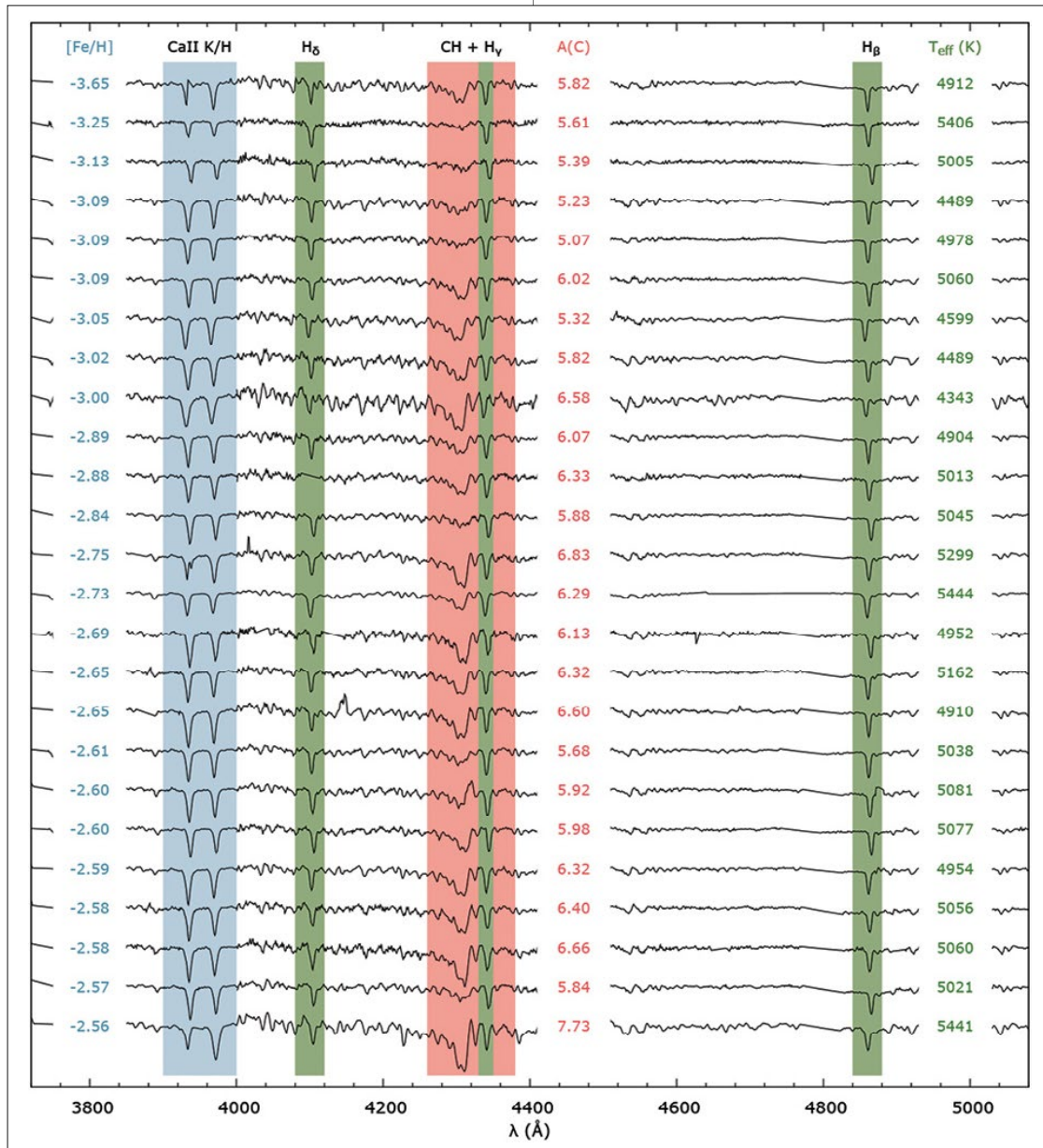

Figure 2. Total counts at 4000 Å as a function of visual magnitude. The size of the symbols is proportional to the exposure time for each object, in seconds.

Figure 3.

Example spectra for 25 stars with $[Fe/H] < -2.5$ observed with Gemini/GMOS (North and South). The shaded areas highlight regions of interest for the determination of metallicity (blue - $[Fe/H]$, Ca II K absorption feature), carbon abundance (red - A(C), CH G-band), and temperature (green - T_{eff} hydrogen Balmer lines). The spectra are ordered by increasing values of $[Fe/H]$.



the already poor weather was lost, which is a great accomplishment for the program and the Observatory.

Scientific Gain from Weather Loss

The spectra gathered at Gemini/GMOS are of sufficient quality (signal-to-noise ratios and spectral resolution) to allow for the determination of stellar atmospheric parameters: effective temperature (T_{eff}), surface gravity, metallicity ($[Fe/H]$), and carbon abundances (A(C)). Figure 3 shows the GMOS spectra of

25 stars with $[Fe/H] < -2.5$ observed under poor weather conditions. The shaded areas highlight absorption spectral features used to determine $[Fe/H]$ (Ca II K absorption feature), A(C) (CH G-band), and T_{eff} (hydrogen Balmer lines). The values for each parameter are also listed. From the 666 stars, metallicities could be determined for 656 (98%), including 477 stars with $[Fe/H] < -1.0$ (73%), 285 stars with $[Fe/H] < -2.0$ (43%), and 9 stars with $[Fe/H] < -3.0$ (including one at $[Fe/H] = -3.65$). Carbon abundances were determined for 653 stars.

The distribution of the carbon abundances as a function of the metallicity for these stars is shown in Figure 4. The lower and side panels show marginal distributions for each quantity. The behavior is similar to that expected from high-resolution spectroscopic samples, which makes this subset important for two reasons: 1) as a tool for target selection, and 2) to have an independent estimate of quantities, such as the fraction of carbon-enhanced metal-poor stars as a function of $[Fe/H]$, which is a crucial observational constraint to Galactic chemical evolution models.

What Have We Learned and What's Next?

The objectives of such follow-up studies, which can include Gemini Poor Weather observations, are two-fold: 1) build statistics of metallicities and carbon abundances determined from medium-resolution spectroscopy, which are crucial for studies of stellar populations and formation of the Milky Way, and 2) select interesting stars for further, more targeted, high-resolution spectroscopy efforts. One effort that is feeding directly from the Gemini data is called the "R-Process Alliance" (RPA) — a multi-stage, multi-year effort to provide observational, theoretical, and experimental constraints on the nature and origin of the astrophysical r-process (rapid neutron-capture).

The parameters determined using the Gemini spectra are extremely useful to tailor target lists for the type of (high-resolution) follow-up conducted by the RPA, and there is already a study published based on an extremely metal-poor star first identified at Gemini (Cain *et al.*, 2018). This star, J2005-3057, shows enhancements in elements formed by the r-process, such as europium, iridium and thorium, among others. Another effort currently underway is gathering

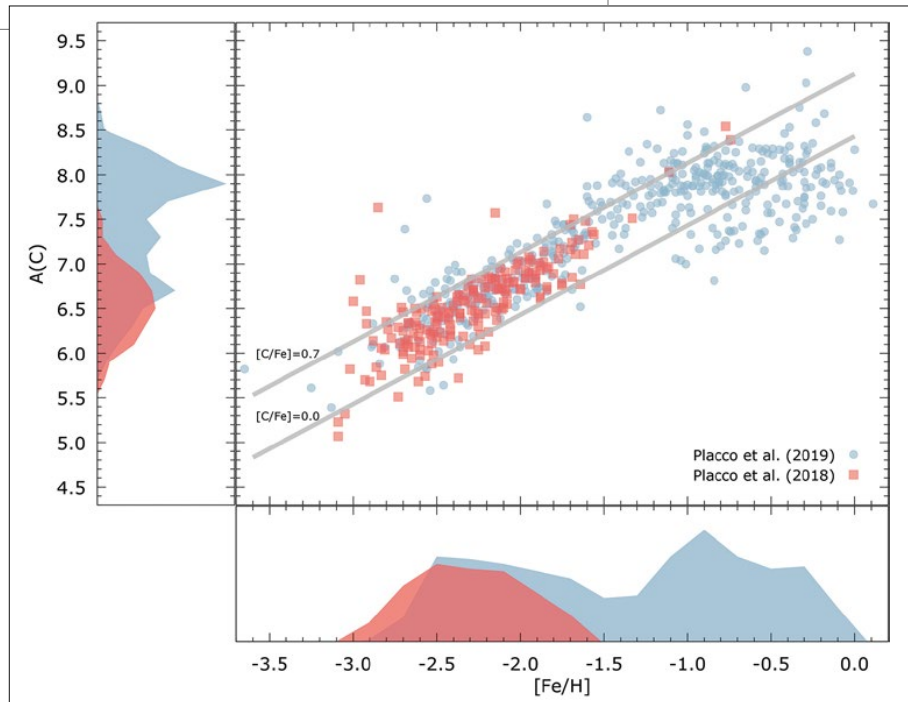

Figure 4. Carbon abundances, $A(C)$, as a function of the metallicity, $[Fe/H]$, for the program stars observed with Gemini. The side and lower panels show the marginal distributions for each quantity.

high-resolution data for the most carbon-enhanced stars identified by Gemini and the results are also promising. Collectively, these discoveries help us paint a more cohesive picture of how the Universe evolved chemically and how we can reshape our current understanding of stellar evolution and galaxy formation. In the near future, such bright stars will be perfect targets for high-resolution spectroscopic follow-up with GHOST, which will be a great asset in pushing these efforts forward.

References

Cain, M., Frebel, A., Gull, M., *et al.*, *The Astrophysical Journal*, **864**: 43, 2018
 Placco, V. M., Beers, T. C., Santucci, R. M., *et al.*, *The Astrophysical Journal*, **155**: 256, 2018
 Placco, V. M., Santucci, R. M., Beers, T. C., *et al.*, *The Astrophysical Journal*, **870**: 122, 2019
 Schlaufman, K. C., and Casey, A. R., *The Astrophysical Journal*, **797**: 13, 2014
 Steinmetz, M., Zwitter, T., Siebert, A., *et al.*, *The Astrophysical Journal*, **132**: 1645, 2006

Vinicius Placco is Research Assistant Professor at the Department of Physics at the University of Notre Dame and is located at Notre Dame, Indiana. He can be reached at vplacco@nd.edu



John Blakeslee

Science Highlights

Speckle imaging with DSSI at Gemini South resolves double dip mystery during occultation by Orcean moon Vanth; GNIRS spectra constrain mass of the highest redshift highly magnified quasar; and high-definition GeMS/GSAOI data reveal the age of an ancient, dust-obscured star cluster deep in the Milky Way's bulge.

Vanth Surprises with Double Dip During Occultation

The sizes and surface compositions of trans-Neptunian objects (TNOs) are notoriously difficult to study. As seen from Earth, the largest TNO has a maximum angular size of about 0.1 arcsecond; more typical ones are unresolved at 0.01 arcsecond or smaller. Except for the two TNOs that have been visited by spacecraft, the most direct measurements of TNO sizes come from stellar occultations. Consequently, planetary scientists exercise great vigilance in taking advantage of these rare opportunities.

One such opportunity occurred on March 7, 2017. Based on ground-based astrometry, it was thought that an occultation of a magnitude $V = 14.6$ star by the large TNO Orcus would be viewable from parts of the Pacific and the Americas on that date. With an estimated diameter in excess of 900 kilometers (km), Orcus likely meets the shape criteria for a dwarf planet. Like Pluto, it is in a 3:2 orbital resonance with Neptune, has a semi-major axis of 39 astronomical units, and a high eccentricity. It has one large satellite named Vanth, which orbits with a period of 9.5 days. With the availability of astrometry from the Gaia space mission, it became clear that Vanth, rather than Orcus, would be the one tracing a path of occultation across the Earth's surface on the predicted date.

In anticipation of this event, an international team of occultation-chasers led by Amanda Sickafoose of the South African Astronomical Observatory organized a monitoring campaign with five telescopes located in Hawai'i, California, Texas, and Chile. To their surprise,

the coordinated observations detected two non-simultaneous dips in the stellar brightness at two widely separated telescopes. The detections were made by the NASA Infrared Telescope Facility on Maunakea, and the Las Cumbres 1-meter telescope at the McDonald Observatory in Texas. The observations could not be explained by a single object occulting a single star; moreover, previous *Hubble Space Telescope (HST)* data ruled out the possibility of another satellite of sufficient size to explain the second dip in stellar brightness.

To test the occultation star for possible multiplicity, the team applied for Fast Turn-around time with the visiting Differential Speckle Survey Instrument (DSSI) at Gemini South. The proposal, led by Amanda Bosh of the Massachusetts Institute of Technology, was successful, and the observations were quickly processed by the DSSI instrument team. The resulting image, shown in Figure 1, reveals that the occultation star is indeed a double, with a separation of 250 milli-arcseconds and a brightness differen-

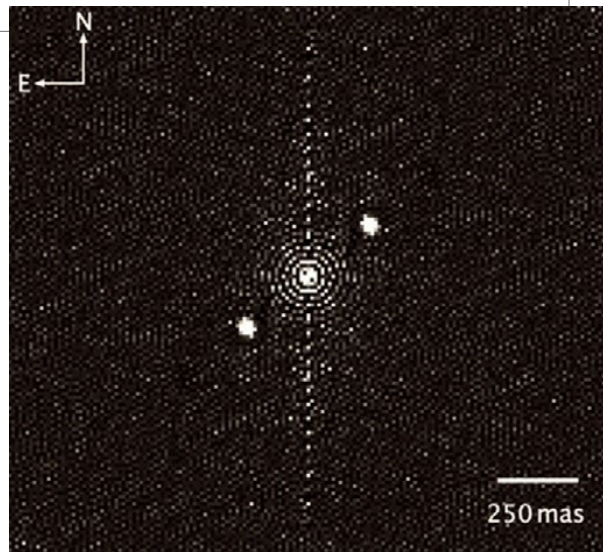

Figure 1. Gemini South DSSI image of the star pair occulted by Vanth, a satellite of the large trans-Neptunian object Orcus. This image consists of 1,000 seconds of speckle data combined to reveal the binary pair responsible for the observed double occultation. The bright primary is at center, and the newly detected companion is at upper right (approximately 2:00 position; the other “star” at the 8:00 position is an artifact of the autocorrelation analysis used in speckle processing). [Figure reproduced from Sickafoose et al., *Icarus*, **319**: 657, 2019.]

tial of about 0.9 magnitude in the red DSSI bandpass. Figure 2 compares the original prediction for the single path of occultation by Vanth with the paths of the two occultations as reconstructed from the binary star positions in the DSSI data. The reconstructions fit perfectly with the observations.

Once the binary nature of the occultation star was revealed by Gemini/DSSI, the two observed occultations, combined with non-detections at the other sites, allowed the team to place a tight constraint of 443 ± 10

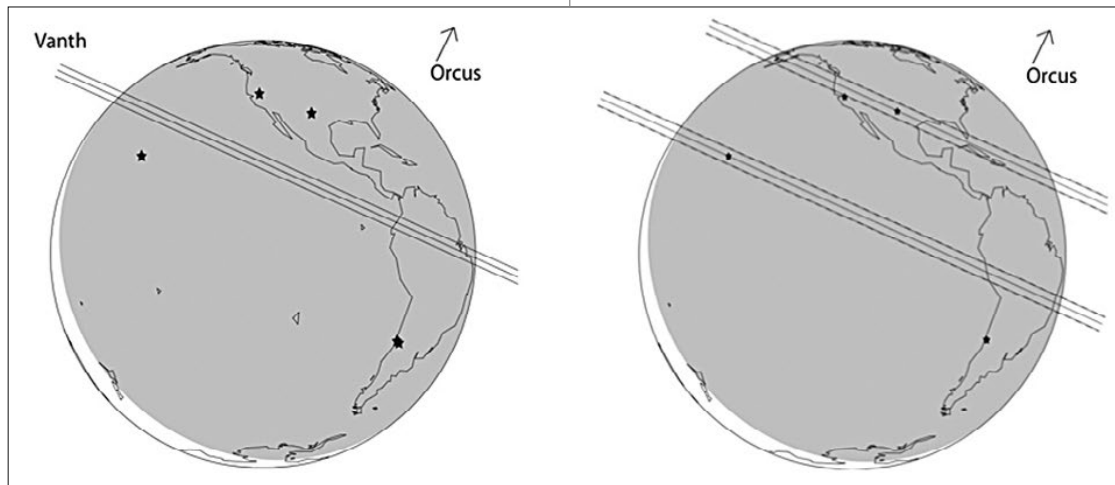

Figure 2. The dual paths of Vanth. Left: The predicted path of Vanth’s shadow during the occultation of March 7, 2017, based on Gaia DR1 astrometry. The locations of the telescopes participating in the occultation campaign are indicated by stars. The extent of the shadow is indicated for a physical diameter of 280 km; the shadow of Orcus is off the globe. Right: The actual shadow paths of Vanth as reconstructed using the positions of the two components of the double star determined from Gemini/DSSI imaging. The brighter star was occulted along the upper path, which passed over the observing location in Texas, but was not detected at the location in California. The occultation of the fainter star occurred along a path that passed over the observing location in Hawai’i; no occultations were detected at the locations in Chile. The paths are drawn for a Vanth diameter of 442.5 km, the size determined from these observations.

[Figure reproduced from Sickafoose et al., *Icarus*, **319**: 657, 2019.]

Figure 3.

Gemini was one of several large telescopes that contributed to the study of the lensed quasar J0439+1634, selected as a candidate high-redshift object because it is an r-band “dropout” with little i flux (top). The 6.5-m MMT and 10-m Keck-I telescope obtained optical spectra (outlined in cyan), while the 8.1-m Gemini North telescope obtained an infrared spectrum (outlined in red). The width of the Mg II line near 2100 nm constrains the mass of the black hole powering the quasar. The 2 × 8.4-m Large Binocular Telescope captured an adaptive optics corrected image that suggests the quasar is lensed, later confirmed by HST.

Credit: Feige Wang (UCSB), Xiaohui Fan (University of Arizona)

km on the diameter of Vanth. Remarkably, this is 60% larger than previous estimates, and roughly half as large as the estimated size of Orcus. The results also placed a limit of a few microbars on any possible atmosphere around Vanth. The study has been published in the journal *Icarus*, and a [pre-print is available online](#).

The Mass of the Most Distant Lensed Quasar

Observations from the Gemini Near-Infrared Spectrograph (GNIRS) have confirmed the redshift and constrained the mass of the brightest quasar yet discovered at redshift $z > 5$. However, the discovery paper led by Xiaohui Fan of the University of Arizona concludes that the object, known as J0439+1634, is not the intrinsically most luminous quasar at this redshift. Rather, its apparent brightness has been boosted by a factor of about 50 by the gravitational magnification of an intervening galaxy. This makes J0439 + 1634 the most distant known strongly lensed quasar, and perhaps the first of many waiting to be revealed through high-resolution imaging.

Several decades ago it was proposed that a substantial fraction of the most distant qua-

sars found in flux-limited surveys would be brightened above the survey limit by gravitational lensing. If this is the case, the resulting “magnification bias” would cause a systematic overestimation of the masses of the supermassive black hole population powering high-redshift quasars. However, no multiply-imaged lensed systems had ever been found above redshift $z = 4.8$ (a lookback time of about 12.5 billion years), despite intensive high-resolution follow-up of hundreds of quasars known beyond this redshift. It may be that the extended appearance of multiply-lensed quasars, and/or color contamination by the lensing galaxy, causes a strong selection bias against these systems.

Fan’s team selected J0439 + 1634 as a high-redshift quasar candidate based on a combination of imaging data from the Pan-STARRS1 survey in the optical, the UKIRT Hemisphere Survey in the near-infrared, and archival *Wide-field Infrared Survey Explorer* data in the mid-infrared. Follow-up optical spectroscopy with the 6.5-meter (m) Multiple Mirror Telescope and 10-m Keck I telescope showed a prominent spectral break consistent with a redshift near 6.5 (lookback time of 12.9 billion years). A near-infrared spectrum obtained with GNIRS at Gemini North detected strong Mg II emission, yielding a firm redshift measurement of $z = 6.51$. Figure 3 shows the combined spectrum. From the width of the Mg II line in the GNIRS spectrum, the team derived a mass of almost 5 billion solar masses for the black hole powering the quasar, and the photometric measurements implied an astounding total luminosity of 5.8×10^{14} solar luminosities.

However, imaging obtained with adaptive optics on the 2 × 8.4-m Large Binocular Telescope indicated that J0439 + 1634 was broader than a point source, suggesting the presence of either a host galaxy or multiple images. Higher resolution

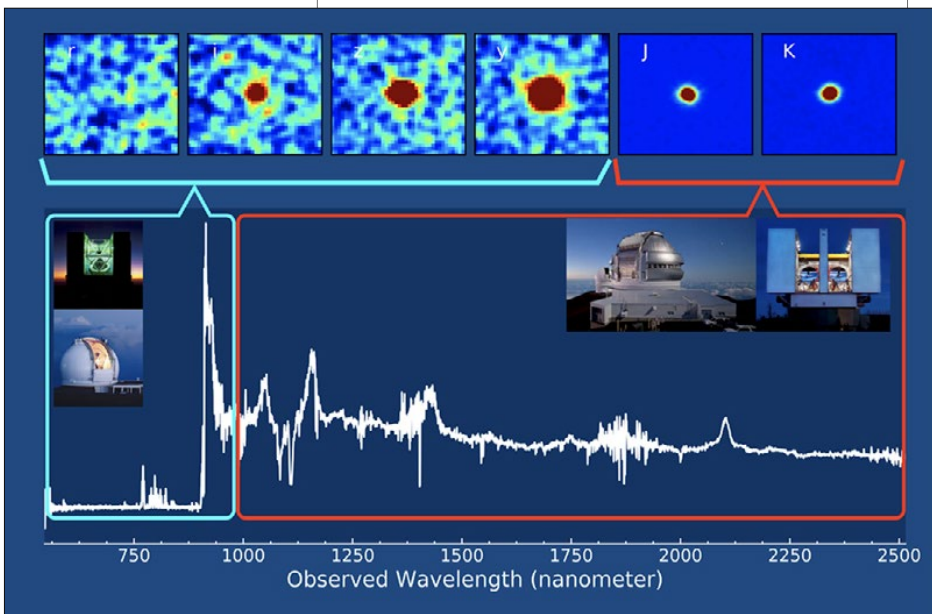

imaging with *HST* clearly resolved the system into multiple lensed components with a maximum separation of about 0.2 arcsecond, plus an extended source about 0.5 arcsecond away, interpreted as the lensing galaxy. Photometric analysis implied a redshift of about 0.7 and a mass of 6.3 billion solar masses for the lensing galaxy. Based on these measurements, the team derived a best-fit lensing model with three quasar images and a total magnification factor of 51.3. After correcting for the magnification, the inferred luminosity of J0439+1634 drops to “only” 1.1×10^{13} solar luminosities, and its black hole’s mass becomes a pedestrian 430 million solar masses. Together these estimates imply an extremely high mass accretion rate, as required to grow such a large black hole at early times.

The results of this study indicate that many strongly lensed, high-redshift quasars could have been missed by past surveys because standard color selection criteria will fail when the quasar light is contaminated by a lensing galaxy. Thus, changing the techniques for selecting quasars could significantly increase the number of lensed quasar discoveries. “This discovery demonstrates that strongly gravitationally lensed quasars do exist at redshift above five, despite the fact that we’ve been looking for over 20 years and have not found any others this far back in time,” said Fan. “However, we don’t expect to find many quasars brighter than this one in the whole observable Universe.”

The study has been published in [The Astrophysical Journal Letters](#).

Excavation of an Ancient Star Cluster Deep in Milky Way Bulge

Of the roughly 160 globular clusters known in the Milky Way, roughly a quarter appear to be associated with the Galactic bulge. Although these are generally more metal rich



than those of the halo, a subclass of moderately metal-poor ($[Fe/H] < -1.0$), α -enhanced ($[\alpha/Fe] > +0.3$), bulge globular clusters with blue horizontal branches are thought to be among the oldest stellar systems in the Galaxy. In this scenario, the moderate metallicities of these ancient star clusters result from the early, rapid chemical enrichment of the Milky Way’s innermost regions.

One such candidate “fossil relic” of the bulge’s early formation is HP 1, a globular cluster just 3° away from the Galactic Center with 3.7 magnitudes of visual extinction. High-dispersion spectroscopy of member red giants indicates that HP 1 has metallicity $[Fe/H] \approx -1.1$ dex and is α -enhanced by about a factor of two. However, the age had been uncertain because past photometric studies were unable to reach beyond the main sequence turn-off (MSTO).

A new study by an international team of astronomers presents a detailed analysis of deep near-infrared observations of HP 1 obtained with the Gemini South Adaptive Optics Imager (GSAOI) using the Gemini Multi-conjugate adaptive optics System (GeMS). The GeMS/GSAOI J and K_s images, shown in Figure 4 (also featured on the cover of this issue), have spatial resolution of about 0.1 arcsecond and probe two magnitudes be-

Figure 4. The Gemini GeMS+GSAOI J, K color composite image of HP 1 (right) is shown within the context of a larger field imaged under natural seeing conditions by the Visible and Infrared Survey Telescope for Astronomy (VISTA, left). Note: the background of the right-hand image is featured on the cover of this issue of *GeminiFocus*.

Figure 5.

Results of fitting the GeMS near-infrared CMD of HP 1 using the Dartmouth Stellar Evolutionary Database (DSED) models. Left panel: CMD showing all likely member stars (grey) and those used in the fit (black). The best-fit isochrone is indicated by a thick green line; the green shading shows the uncertainty range. The red arrow indicates a change in reddening of $\Delta E(B - V) = 0.10$ mag. Right panels: The resulting one- and two-dimensional constraints for all model parameters. The contours correspond to confidence levels of 0.5σ , 1.0σ , 1.5σ , and 2.0σ . [Figure reproduced from Kerber et al., Monthly Notices of the Royal Astronomical Society, **484**: 5530, 2019.]

low the MSTO. The study was led by Leandro Kerber of the Universidade de São Paulo and Universidade Estadual de Santa Cruz in Brazil.

The team combined their GSAOI data with archival F606W (wide V) images from the HST's Advanced Camera for Surveys to determine relative proper motions and select bona fide cluster members. They then fitted two different sets of model isochrones to the color-magnitude diagrams (CMDs) to determine the stellar population parameters, distance, and reddening. Figure 5 shows the results for one set of isochrones using only the GeMS/GSAOI data; the team also performed fits to CMDs made with a combination of HST and GeMS data. The analysis indicates an age near 13 billion years, confirming that HP 1 is one of the oldest globular clusters in the Milky Way and likely formed less than a billion years after the Big Bang.

The heliocentric distance of 6.6 kiloparsecs (kpc) estimated from the isochrone fitting agrees well with the distance implied by the extinction-corrected brightnesses of 11 RR Lyrae stars identified within the cluster. The team combined this distance with the

measured radial velocity and the absolute proper motion given by Gaia (Data Release 2) in order to constrain the cluster's orbit. They find that HP 1 passes just 0.12 kpc from the Galactic Center at closest approach and reaches a maximum distance of about 3 kpc. It is likely that many of the cluster's stars have been stripped away as it has repeatedly plunged through the bulge during the course of its long history.

"HP 1 is one of the surviving members of the fundamental building blocks that assembled our Galaxy's inner bulge," said Kerber. Added coauthor Mattia Libralato of the Space Telescope Science Institute, "The combination of high angular resolution and near-infrared sensitivity makes GeMS/GSAOI an extremely powerful tool for studying these compact, dust-enshrouded stellar clusters." The study appears in [Monthly Notices of the Royal Astronomical Society](#).

John Blakeslee is the Chief Scientist at Gemini Observatory and located at Gemini South in Chile. He can be reached at: jblakeslee@gemini.edu

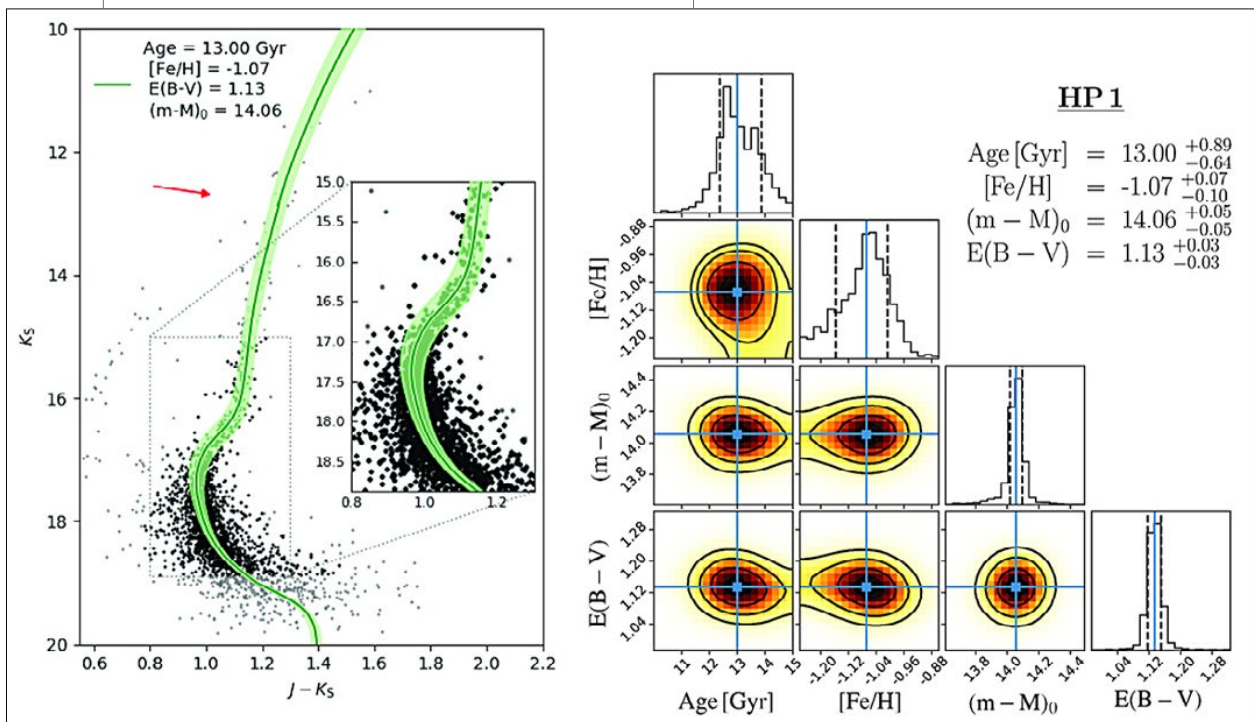



Gemini staff contributions

On the Horizon

GEMMA is making progress on several fronts; visiting instrument MAROON-X may complete commissioning in time for the 2020A Call for Proposals; GHOST successfully completes its second round of on-sky testing, including its interoperability with the Observatory Control System; and SCORPIO is being readied for its Critical Design Review.

GEMMA's Out of the Gate

In the new year, the Gemini in the Era of Multi-Messenger Astronomy (GEMMA) program is off to a good start. Gemini North Adaptive Optics (GNAO) Principal Investigator Gaetano Sivo formed an external Gemini AO working group to provide community experience and expertise regarding the Observatory's AO program, including developing science cases, technical recommendations, and best practices. The Real Time Computer project is performing some technology trade studies and considering whether some components can be designed and built in-house.

The time-domain astronomy (TDA) project is also moving along, convening a working group to review user stories related to the concept of operations. In addition, Public Information and Outreach plans to hold a Time-Domain Astronomy Summit later this year; the goal is to bring together scientists and communications and education professionals to create a road-map on how to communicate the concepts of MMA and TDA to non-scientists. The program continues to define short- and long-term benefits of the individual projects to the future of Observatory operations and the astronomy community. Dave Palmer has joined the team to work as Project Manager for both the GNAO and RTC GEMMA efforts. He will be working

Figure 1.

Computer-aided design rendering of the vacuum chamber and cameras on the MAROON-X bench. The actual spectrograph is expected to arrive at Gemini North in May.

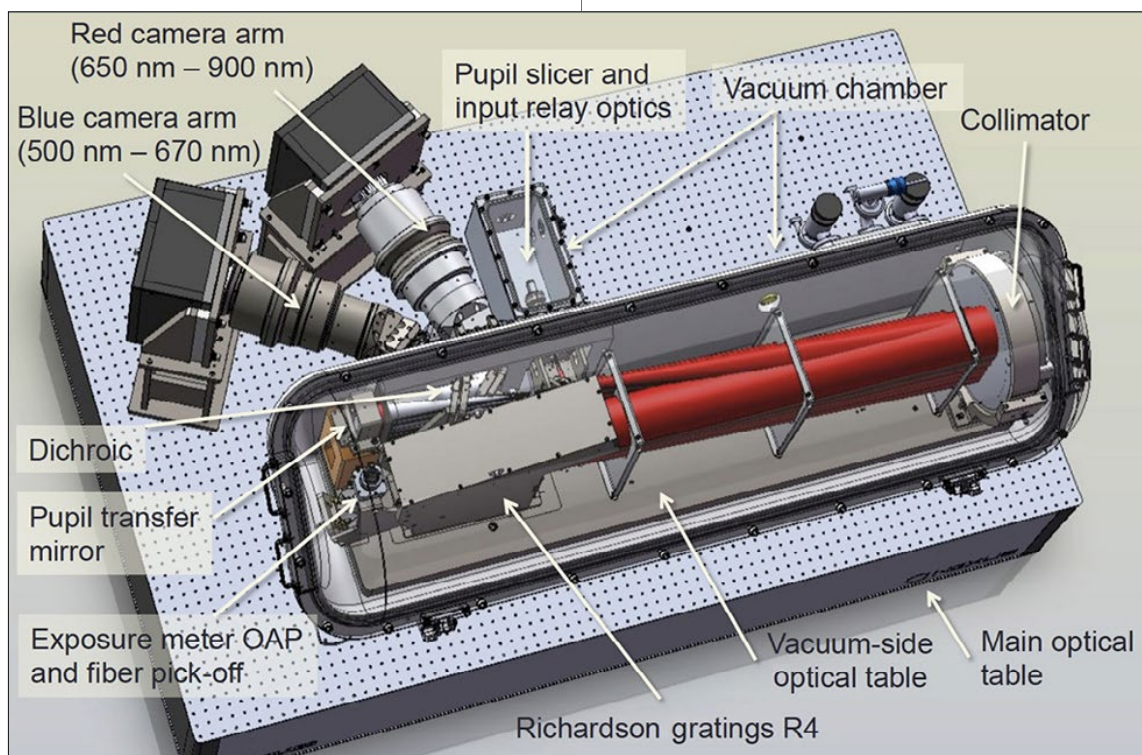

with Acting GNAO Project Manager Stephen Goodsell during the Conceptual Design Stage, allowing Stephen to step back from the role after the Conceptual Design Review.

Preparations for MAROON-X

MAROON-X is the new radial velocity spectrograph being built at the University of Chicago and expected to be deployed at Gemini North within the next year (Figure 1). This high-resolution, bench-mounted spectrograph has been designed to deliver 1 meter/second radial velocity precision for M dwarfs down to and beyond $V = 16$, and is expected to have the capability to detect Earth-size planets in the habitable zones using the radial velocity method.

Following the success of the Front End commissioning, we are planning to install and align the spectrograph in the dedicated enclosure in the Pier Lab in May 2019. If all goes well, we hope to complete commissioning in time to include this exciting new visiting instrument in the 2020A Call for Proposals.

Watch this space for more information as integration and commissioning progresses on Maunakea.

Second On-sky Testing of GHOST

The Gemini High-resolution Optical Spectrograph (GHOST) team completed the second round of on-sky testing at Gemini South in November, 2018. The team successfully demonstrated proper operation of the atmospheric dispersion correctors (ADCs), the instrument on the side-port of the instrument support structure, and the interactions between GHOST and the Observatory Control System (OCS) software.

GHOST uses ADCs to correct for the dispersion of light by the atmosphere. Rather than a full-field ADC, GHOST features mini-ADCs for each fiber positioner, which offers improved efficiency. The build team tested each of the mini-ADCs to ensure that the hardware and software were working correctly to provide the optimal dispersion correction as expected. Each ADC was tested

over a range of target zenith distance and position angles. These tests demonstrated that the ADCs are working as expected and produce the required correction.

These tests also marked the first on-sky testing of GHOST interoperability with the Gemini OCS. GHOST target configurations, in both high- and standard-resolution modes, were created in the Gemini Observing Tool. The telescope systems then used these target configurations to determine the telescope pointing. GHOST also used them to place the fiber positioners on the requested targets. While these successful tests were a major milestone in our internal software development process, they also improved the efficiency of the on-sky tests by greatly reducing the time for target acquisitions at the telescope.

The team operated GHOST on both the up-looking and side-looking ports. While GHOST is expected to operate primarily on the up-looking port during normal operations, we wanted to ensure proper operation on the side-looking port, as well. This mainly consisted of checking that the GHOST operations software was properly accounting for the additional reflection produced by the tertiary (science-fold) mirror and producing the correct coordinate transformations and ADC corrections, among other things. With some minor tweaks, GHOST worked successfully on the side-port.

The team used the prototype optical fiber cable for this round of Cassegrain unit testing. The science optical fiber cable is nearing build and test completion. Upon completion, the cable and Cassegrain unit build team (the Australian Astronomical Optics Group at Macquarie University) will ship these components to the spectrograph build team at the National Research Council Herzberg in Victoria, Canada, where they

will be paired with the spectrograph for testing in the second half of 2019. The Australian National University team, along with a contractor, Software Design Ideas, is providing the instrument control and data reduction software for GHOST; they were also instrumental in the November Cassegrain unit testing, as were Gemini project team members from both North and South sites.

SCORPIO Update

At the end of February, Southwest Research Institute (SwRI) hosted a progress meeting in San Antonio, Texas, to assess the maturity of the SCORPIO project's Critical Design Review (CDR) documentation set. SwRI has provided Gemini with drafts of the Critical Design documents and the team continues to work on providing additional structural and thermal analysis required for the review. A readiness assessment will take place at the beginning of April. The project has now received the instrument's four science grade visible detectors.



Gemini staff contributions

News for Users

Register now for International Astronomical Union Symposium 357; advisory group meets twice to help develop plans for Gemini's future in the era of multi-messenger and time-domain astronomy; laser guide star observing is now available at Gemini North throughout the semester; development of the Next Generation Natural Guide Star sensor for GeMS has achieved a major milestone; we take stock of program completion statistics for Semester 2018B; and Gemini North stands tough against severe winter winds.

Registration is Open for IAU Symposium 357

Registration is now open for International Astronomical Union (IAU) Symposium 357: White Dwarfs as Probes of Fundamental Physics and Tracers of Planetary, Stellar and Galactic Evolution, which will be held in Hilo, Hawai'i, from October 21-25, 2019. Full details, and a link to the registration site, can be found on the [conference website](#). The deadline for registration is June 30, 2019. Space is limited so please register early.

Applications for travel grants are also now open. Please note the earlier deadline of May 31, 2019, to allow processing and approval by the IAU.

GEMMA-TDA Advisory Group Assembled

Guided by a Gemini Science and Technology Advisory Committee action regarding time-domain astronomy (TDA) and multi-messenger follow-up, we have assembled a representative team of astronomers from across the Partnership to advise us on our developing plan for TDA. This advisory group, chaired by Abhijit Saha of the National Optical Astronomy Observatory (NOAO), has had two meetings as of early March.

The members are: Abhijit Saha (US; NOAO) - Chair; Andres Jordan (CL); David Sand (US); Basilio Santiago (BR); Meg Schwamb (Gemini); Federica Bianco (US); Myungshin Im (KR); Maria Drout (CA); Craig Heinke (CA); Victoria Alonso (AR); Alexander Vanderhorst (US); Andy Adamson (Gemini, in attendance); Bryan Miller (Gemini, in attendance); John Blakeslee (Gemini, in attendance).

Not all of the members of this time-domain advisory group work on time-domain science; the mission of the group includes protecting the completion of non-TDA programs in the coming Large Synoptic Survey Telescope era when we expect to have an increased number of Target of Opportunity proposals. We are grateful to Abi and the group for helpful commentary to date.

TOPTICA Laser: Available Every Night!

With a fully commissioned TOPTICA laser, we are back in operation for Laser Guide Star (LGS) mode at Gemini North. The 19A semester will be a "transition" period from scheduled laser blocks to a fully-integrated LGS queue operations model. This will allow for LGS programs to be observed on any night when conditions allow, giving Gemini Principal Investigators access to LGS adaptive optics observing throughout the semester (Figure 1).

The Next Generation Natural Guide Star Sensor for GeMS

Gemini-South's Multi-conjugate adaptive optics System provides for an adaptive optics (AO) corrected field of about one arc-minute. To achieve this important capability, the system relies on a constellation of five laser guide stars and up to three natural guide stars in order to sense and correct for atmospheric turbulence. The original design of the natural guide star sensor has been in operation now for several years. It is based around three mechanical probes picking up stars in the field. Each probe channels the light onto optical fibers leading to avalanche photodiodes for fast centroiding. Unfortunately, the sensitivity of this system leaves much to be desired, and the mechanical arrangement is complex in operation.

Therefore, some years ago, Gemini entered into a collaboration with the Australian National University (ANU) to develop a better system designed around the now available high-speed Electron Multiplying (EM) CCD cameras. Using an EM CCD imager will result in much improved sensitivity. The moving probes will no longer be necessary, as the full patrol field will be imaged onto the CCD, while regions of interest around the selected stars will be read out at high speed to provide centroiding information to the

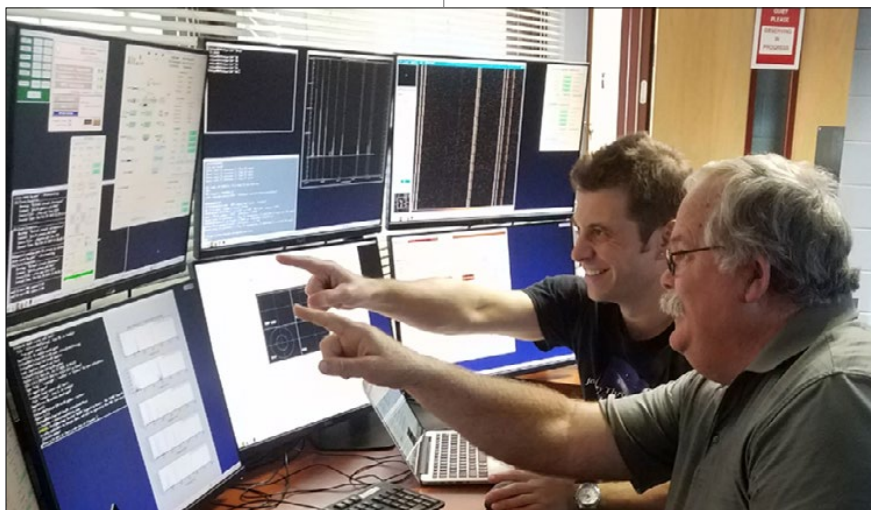
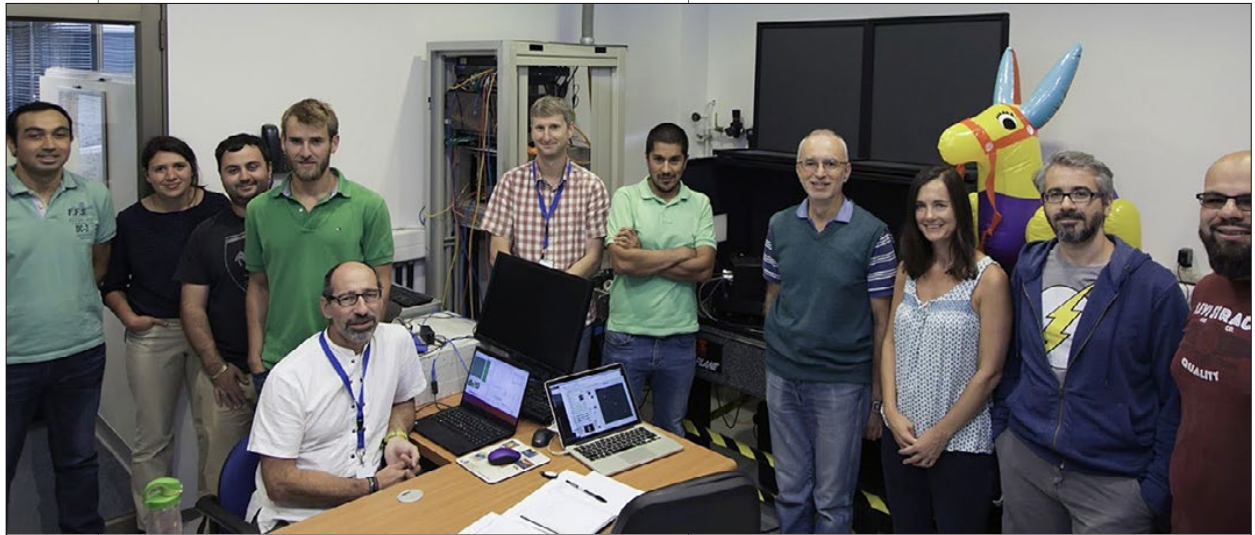

Figure 1.
Gemini Science Operations Specialist Michael Hoenig (back) and Gemini Senior Laser Technician Jeff Donahue discussing LGS operations for the TOPTICA laser in the Gemini Base Facility Control Room in Hilo. Credit: Jeff Donahue

Figure 2.



The NGS2 test team, from left to right: Cristian Moreno, Mariah Birchard, Gaetano Sivo, Brian Chinn, François Rigaut, Ian Price, Ignacio Arriagada, Pedro Gigoux, Natalie Provost, Gianluca Lombardi, and Eduardo Marin. René Rutten is on the business end of the camera.

Credit: René Rutten

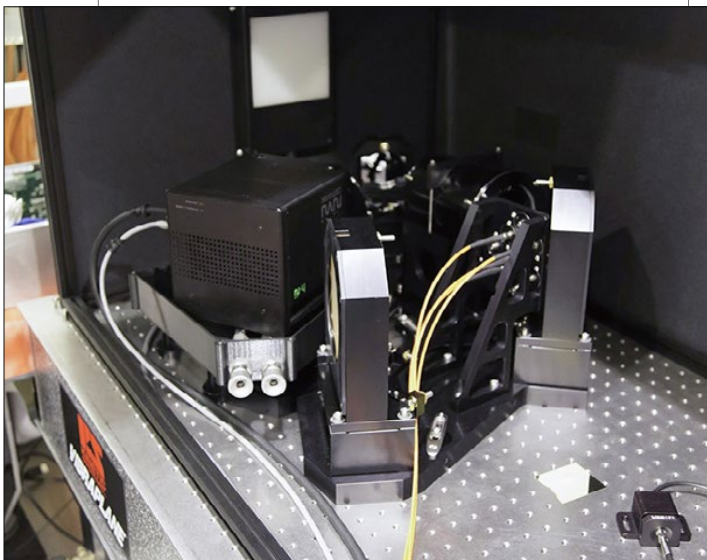

Figure 3.

The NGS2 unit on the test bench in La Serena. The high-speed EM CCD camera is on the left-hand side. The orange lines are fibers to mimic multiple guide stars that are imaged onto the detector.

AO real-time control system. This results in much simpler acquisition procedures, and achieves much better sky coverage, since fainter stars will become accessible.

In February a major milestone was achieved on this project. The system developed by ANU arrived in La Serena, Chile, where it was installed on a test bench and integrated with the AO real-time control system (Figures 2 and 3). The results have been excellent, proving that the system will work as designed. Much work remains to be done. Integration of the new system, named “NGS2,” in the existing multi-conjugate AO system will not be a trivial task. If all goes well, we expect to do this early in Semester 2019B.

Semester 2018B Outcomes

We’re now in the thick of Semester 2019A and taking stock of the outcome of 18B. Preliminary completion results for programs in the regular queue (in other words, excluding Targets of Opportunity and block-scheduled instrument modes) are shown in Figure 4 (following page). Band 1 programs at both sites fared rather well, three quarters of them reaching 100% completion. In the North, Band 3, which typically takes the more relaxed observing conditions, fared relatively worse — another reflection of the fact that 18B was better than either of the preceding B semesters in Hawai’i.

In the South, the completion rate was better than it has been for many semesters, thanks to a healthy percentage of stable, good conditions despite the loss of five nights to a major earthquake in January 2019. Note that in 18B we took data on the last of the traditional “rollover” programs; from now on, regular queue Band 1 programs (except Target of Opportunities, Fast Turnaround, Director’s Discretionary, and Large and Long Programs) have one semester of “persistence,” and so some of those will continue to accumulate data as we continue into 2019A.

Semester 2018B at GS

Total programs: 55

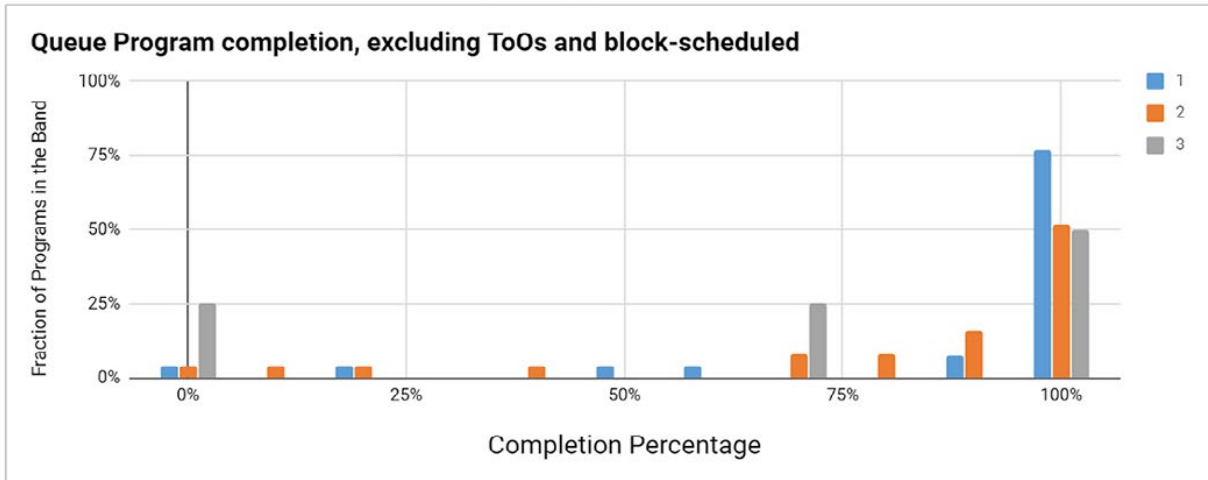

Semester 2018B at GN

Total programs: 72

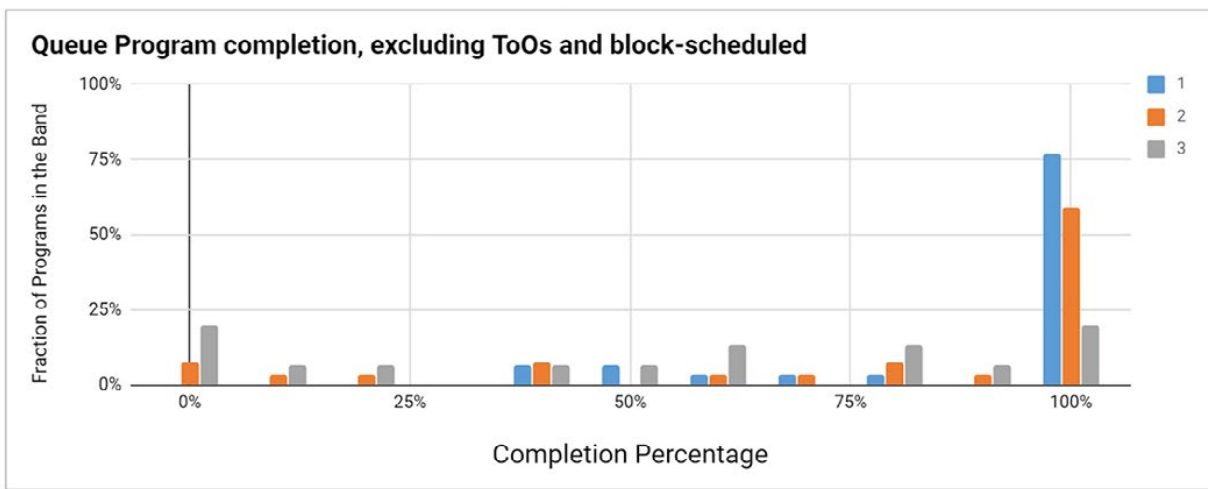

Figure 4.

For Gemini South (upper) and Gemini North (lower) the completion histogram for Semester 2018B. Horizontal axis shows the program completion in 10% bins, and vertically the colored bars show the fraction of programs in Bands 1, 2, and 3, which reached that completion percentage. Main features are described in the text. Credit: Andy Adamson

Gemini North Survives Wild Weather

As we reported in our recent e-newscast, on February 10, 2019, a low-pressure system (Figure 5) subjected Maunakea to some of the highest wind speeds ever recorded. While there's reason to be skeptical of the widely-reported peak gust speed of 191 miles per hour (mph), winds in excess of 150 mph (just below Category 5 Hurricane force) were reliably recorded on the summit on that day (Figure 6; following page).

Winds of that speed at this elevation, pushing on a structure of the scale of the Gemini dome, is sufficient to produce a force of around 280 tons sideways. The Gemini tele-

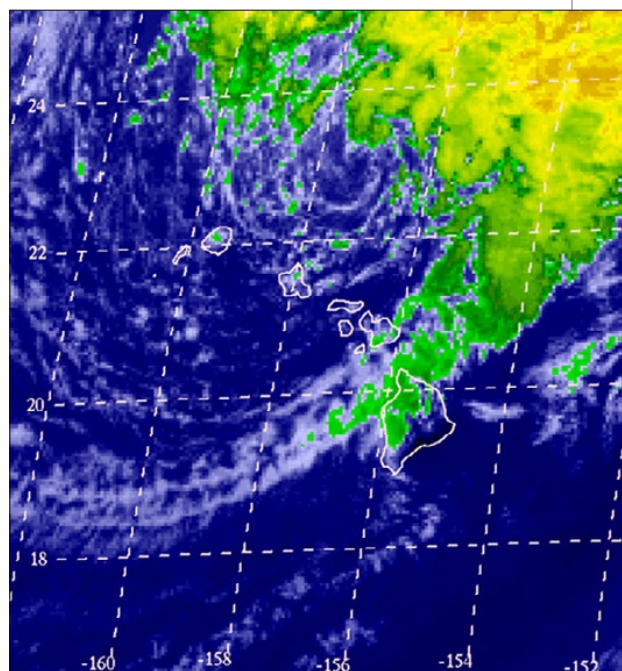

Figure 5.

The low-pressure system to the north of the Hawaiian Islands, on February 10, 2019, Hawaiian Standard Time. The circulation center is clearly visible in the lower-level cloud pattern (in grey). Image taken from the [MKWC satellite archive](#); go there and select 11-Feb UTC to see animations.

scope facility is rated to survive such winds with no distress to materials or structure. Even somewhat stronger winds of order 160 mph would not threaten the structure, as deformations would remain below the elastic limit. However, at 200 mph, significant failures would be expected. The recent additions to the support building, namely the many solar panels and base-facility operation environmental sensors, were designed to the same wind speed standard as the rest of the building, and all survived the wind event intact and remained functional.

This wasn't a particularly unusual storm system; it was a "Kona low," a low-pressure system which usually settles to the west of the islands (hence the name) but which this time was to the north. To put the wind speeds in perspective, an extreme winter storm on Mount Washington in New Hampshire, USA, in 1934, produced a wind gust of 231 mph, and in 1996 Cyclone Olivia produced a wind gust of 253 mph, setting a new world record.

Figure 6.

Top panel: The CFHT/Gemini observed weather data from the [Maunakea Weather Center site](#), at the time (16:43 HST) of the highest gust experienced there — 161 mph (top row, middle, red).
Bottom panel: This screenshot from the Maunakea Weather Center shows a wind speed of 96 knots (110 mph) recorded by the CFHT/Gemini weather tower on February 10th at 16:40 HST (bottom frame).

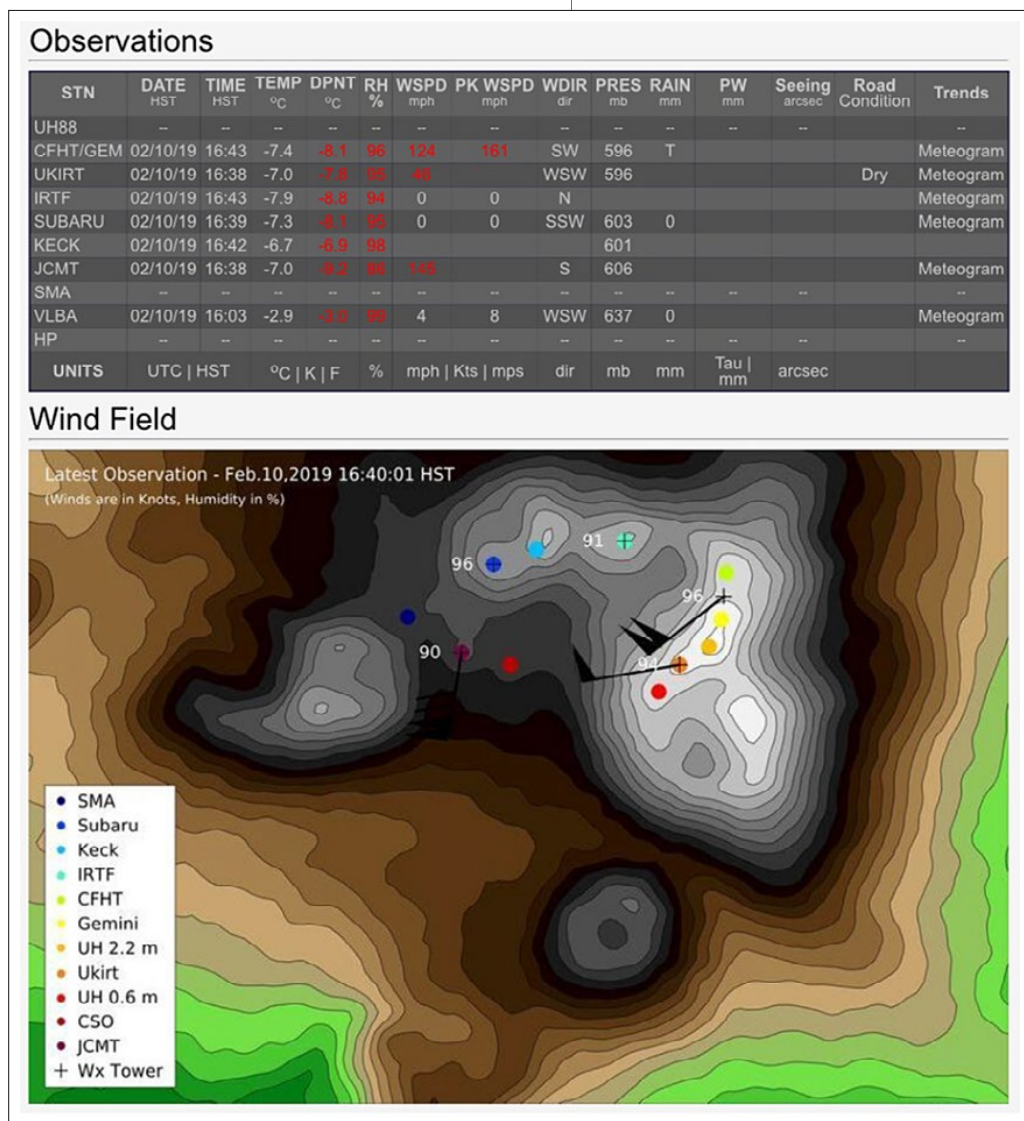



Manuel Paredes and Alyssa Grace

Gemini Outreach Programs Sparkle in Both Hemispheres

Gemini's two leading public outreach endeavors — AstroDay Chile and Journey Through the Universe continue to uphold one of Gemini's primary missions: to share the wonders of the Universe with the public.

Astroday Chile 2019: Preparing our host communities for the July 2nd Total Solar Eclipse

With excitement mounting over the upcoming July 2nd total solar eclipse over La Serena, Chile, *AstroDay Chile* on March 23rd was primed to educate its ~3,000 visitors about this special event. Held at the Seminario Conciliar School of La Serena, the program provided educational material and talks about the eclipse, and taught participants how to view the partial phases safely (Figure 1, page 22). Numerous other activities and exhibitions were also featured. To help make *AstroDay Chile* 2019 a success, 23 organizations joined in on the excitement of bringing astronomy to the people.

Coordinated by Gemini South's Public Information Office, the event offered to students, families, and the public, a wide variety of activities, such as science workshops, lectures, 3D cinema, water-rocket launches, solar viewing, and portable planetarium presentations.

Two key partners helped organize this year's event: the Association of Universities for Research in Astronomy (AURA), and the Municipality of La Serena. All of the major observatories in Chile — including the European Southern Observatory (ESO), ALMA, and Las Campanas — and most of the astro-tourist facilities in the surrounding Coquimbo Region also united to participate in this year's program.

The images shown on page 22 illustrate some of the the activities of the day.

Manuel Paredes is the Communications Coordinator at Gemini South. He can be reached at: mparedes@gemini.edu

Figure 1. Families took advantage of AstroDayChile's special solar-viewing event to learn how to safely observe the total solar eclipse on July 2nd in the Region of Coquimbo.



Figure 2. A mother helps her kids inject air into a water rocket for an amazing lift off! This workshop was the one most preferred by children and adults during AstroDay Chile.



Figure 3. After sunset, many participants formed lines to see the Moon and stars through telescopes supplied by local amateur astronomers and the Cerro Tololo Inter-American Observatory. Through their kindness and help, AstroDay fulfilled its promise to share the wonders of the Universe.



Figure 4. AstroDay Chile was a good venue for the AURA staff to work together in outreach activities. Seen here, from left to right, Gemini Electronics Engineer Vanessa Montes, and Kathy Vivas and Cesar Briceño (both astronomers from Cerro Tololo Inte-American Observatory, interact with the public to explain the science and technologies that AURA centers currently apply in Chile.



Figure 5. The Gemini/AURA booth was one of the most visited, thanks to the help of the kids from the Gemini Robotics Club. They in turn explained to children how robotics can be used to control remote systems, such as the one that controls the Base Facility Operations at Gemini South.



Credit: All photos on this page by Manuel Paredes

Journey Through the Universe: Hawai'i 2019

The 15th year of *Journey Through the Universe*, Gemini Observatory's flagship education and outreach program, brought astronomy professionals from Maunakea and across the nation into Hawai'i island classrooms, visiting thousands of students — one classroom at a time. The diverse group of astronomers, scientists, engineers, and informal educators provided an authentic and personal window into the process of scientific discovery and the splendors of our Universe.

During *Journey* "week," which began on March 2nd, 80 astronomy educators shared their passion for science with approximately 8,000 students. *Journey* as a year-round program also includes StarLab Portable Planetarium shows for grades K-1, career panel presentations for high schoolers, astronomy educator workshops, Lunar and Meteorite Sample Certification workshops hosted by NASA's Solar System Exploration Research Virtual Institute team, Family Science Night, and a public presentation on recent discoveries from the telescopes on Maunakea.

Updates on what *Journey* is accomplishing in the community can be [viewed here](#).

Alyssa Grace is an Outreach Assistant at Gemini North. She can be reached at: agrace@gemini.edu



Figure 5. Hilo-Waiākea and Ka'ū-Kea'au-Pāhoa Complex Area Superintendent Chad Farias speaks about the success of *Journey* in the community and its future.

Credit (all Journey photos): Joy Pollard



Figure 6. Two students learn about robotics provided by the Hawai'i Science and Technology Museum at *Journey's* Family Science Night.

Figure 7. Science Operations Specialist, Jocelyn Ferrara (far left) uses an 8-meter tarp in the classroom to model the size of the primary mirror in the twin Gemini telescopes.



Figure 8.

Digital Architect, Jason Kalawe (standing) discusses careers and career diversity at the Maunakea observatories with local high schoolers.



Figure 9.

Science Fellow, Matt Taylor (fourth from the right), uses a large scale interactive model to show students the relationship between actual distances to stars and perspective.



Figure 10.

Assistant Astronomer, Trent Dupuy (left), helps students understand the scale of star sizes by making paper models.





Gemini South with LSST (Large Synoptic Survey Telescope) being built in the background.

Credit: Javier Fuentes, Gemini Observatory



The Gemini Observatory is operated by the Association of Universities for Research in Astronomy, Inc., under a cooperative agreement with the National Science Foundation on behalf of the Gemini Partnership.



United States



Canada



Chile



Brazil



Ministerio de
Ciencia, Tecnología
e Innovación Productiva
Presidencia de la Nación

Argentina



Korea Astronomy & Space Science Institute
Korea

Gemini Observatory
670 N. A'ohoku Place
Hilo, HI 96720, USA

